

Number 2 | Year 2 | Vol. 2
May-October
English Version



ESPACIO

INNOVACIÓN + DESARROLLO

Index

An overview of Augmented and Mixed Virtual Reality and current programs at the University of Central Florida	4
Using Simulation in Astronautic and Aerospace Systems	14
First stage of Project KID (CID)/ALFA III in Tapachula, Chiapas, Mexico	26
Measuring the attitudes of college students towards the use of ICT	48
Studying Medicine: between Fantasy and Reality	60
Characterization of the subsystem of medicinal plants in the patyotyoty (backyards) in the community of Amado Nervo , Municipality of Yajalón , Chiapas, Mexico.	76
The behavior and thermal comfort of housing in the sustainable rural city of Nuevo Juan Del Grijalva , Chiapas , Mexico.	92
Academic Document	
Educational inequity in Chiapas, a matter of social justice	110

An overview of Augmented and Mixed Virtual Reality and current programs at the University of Central Florida

Brian Goldiez

About the author

Brian Goldiez, Ph.D.
bgoldiez@ist.ucf.edu
University of Central Florida

Introduction

Fundamentally, virtual reality is an artificial environment created entirely by computers. Augmented reality adds technologically generated information to a real world scene. Mixed reality uses some artificial support to enrich an environment of virtual and augmented reality. In all cases, the atmosphere generated by the computer is recorded spatially for a user and responds to your actions in real time. For example, if the user turns his head, the system responds with an appropriate change in the scene.

Augmented reality can be divided into three classes: an augment of something which is not a part of the real world (for example, projecting an object above the head), the augment merged with the real world (For example: including or removing content that is not distinguishable by the user, such as the inclusion of furniture in a real room) , and the augment of real life (For example: using night vision goggles) . Table 1 provides a graphical view about the divisions of augmented reality.

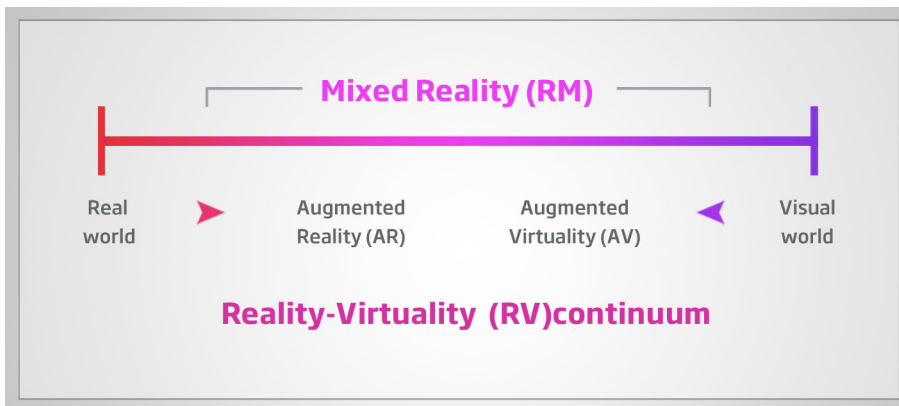

Figure 1.

The fields of mixed and augmented reality are advancing progressively in the movement of established industries, such as advertising, product display, military training and medicine. Furthermore, there is active research community that develops new technologies and who understand their impact on the user. The following images were taken from Wikipedia and are some examples of the implementation of augmented reality.

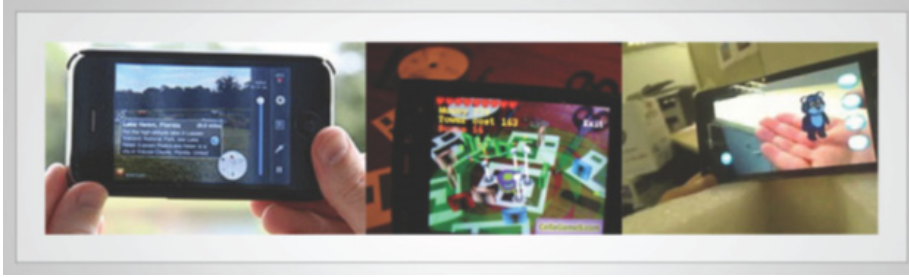

Figure 2.

This document provides a brief description of the research efforts of the Institute for Simulation and Training (IST) at the University of Central Florida (UCF) and mention some major technological changes that have been made and in some cases implemented .

IST is a multidisciplinary research unit at UCF oriented in the advancement of technology and the use of human centered modeling and simulation (www.ist.ucf.edu).

Description of Research Program selection

The investigation at the Institute is conducted on Mixed and Augmented Reality, which is generally supported by one or more of these three topics:

1. Underlying Technology
2. Development of the prototype system
3. Human use

Virtual - physical Avatar

The challenge in many augmented and mixed systems is to make them believable to those who use them. This is particularly important when the virtual part representing a person tries to interact with others. Dr. Greg Welch of IST creates virtual physical persons with the support of the U.S. Office of Naval Research and the National Science Foundation in the USA. These virtual physical people are avatars which are "inhabited" by individuals. This program seeks to incorporate characteristics

of a person in an avatar, and this avatar may have interaction or a relationship with other avatars. The person which is added is a picture of a 3D face template, its body is able to move and act with cameras and at the same time work with 2 audio channels.

A representation of this trend is shown in Illustration 1.

Currently this research represents important technological advances, including the following:

- Show the generation of CGI on a non-planar surface.
- The variation in shadows by illumination can generate algorithmic accounts that help to improve realism.
- Generate a control algorithm that allows the avatar to make a true movement, follow other movements (currently using a motorized wheelchair), and can continue to have a voice and a facial image.
- Increase realism in some specific facial features including its dynamic changes during the interaction.



Figure 3.

Built to learn

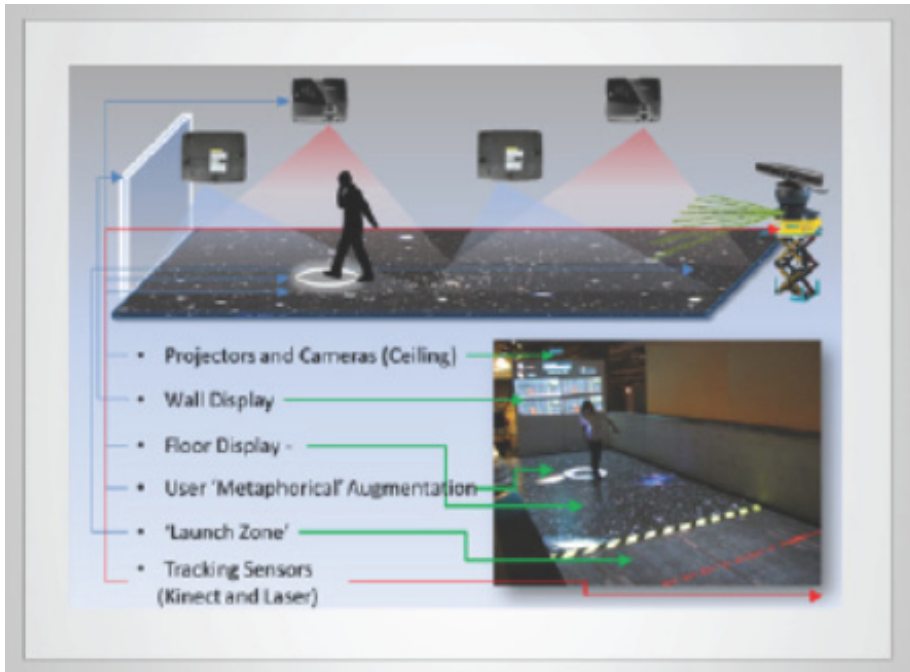

Figure 4.

This project called MEteor seeks to provide an environment where individuals can traverse space and explore various constellations physically. The person is monitored by a special system of cameras and therefore does not use specialized tracking equipment that may be damaged. The system uses a combination of Microsoft Kinect and laser tracking systems. Some important challenges are presented in the lighting, as it can minimize the projection of the participant. The National Science Foundation of the United States supports this research.

Human use

As I mentioned earlier in this paper, augmented reality systems exist today, but there are few students who can identify usefulness in specific applications. Doctors Eduardo Salas and Shirley Sonesh directed their research project to a student who interpreted the operation of a human heart using commercially available augmented reality software. The economic version of the software that is used provides an easy approach for visualization of anatomical structures that can be manipulated by the student with or without textual labels. The re-

search effort involves the evaluation of the different representations of the heart, providing an improvement in medical student training when your example is compared to a model made of fiberglass. As mentioned, medical students are prepared at UCF as target population to assess the training of students using these technologies. Future work will use augmented reality in situations that involve the direct treatment of patients, for example , to remove a phobia of a person who has arachnophobia.

Research Challenges

While the advances that are being made in augmented and mixed virtual reality are very interesting, much remains to be done. Some of the most important challenges include:

- Movements in open spaces
- Packaging
- Shutter speed (speed with which the image is captured)
- Presentation
- Publication of systems
- Presence Control

Mobility is an important aspect, but accommodating movement requires many technological advances. Many of the issues outlined above and further explained below are inclusive, yet it is pertinent to note that several unique aspects are accurately tracked through an open space and fit in a wide sphere according to the brightness, shadows , effects and radios in contrast to the natural environment.

The packaging of virtual reality systems, augmented or mixed, presents several technical challenges. It is also important to note that immersive environments, with all the details, require a special space to store a large amount of equipment and electronic sensors. This system is difficult to move and connect strategically; connecting the individual with the electronic equipment can be a challenge. Also, the equipment's clothing is typically bulky and heavy.

The shutter determines whether the individual is located in the foreground or in the background. These calculations are difficult because they have to be interpreted in real time. Often , you have to sometimes consider the bi -ocular vision of the user, it must be very accurate because the eye can be very sensitive to failures in the scene.

When the user's movements are considered, shutter speed qualifies as a big challenge.

The presentation of these projects shows technical challenges from various perspectives. There are two worlds in the display area, defined by the viewing optics and the video. For optical sight small projectors can be used and half a silver mirror will project the image a little while, allowing the user to look in the mirror and see the entire scene naturally.

These presentations can have optical complications, so you have to register geometrically close to the capture near the scene presented in the real world. This presentation assurance system provides many benefits, because if the projection system fails, the user can still see the natural scenery. The other form of presentation is in video, so the user can see the real and virtual images merged electronically and projected to an external source. While the assurance can be a problem in open environments, this approach has more advantages for the fusion of images in digital mode, which provides more flexibility than optical approach, especially since the setting is visible only through the projection system. Combining video allows control within a radius of luminosity, color adjustment, and digital image alloying.

The descriptions above, although limited in scope and depth, demonstrate that there are many advantages and disadvantages that should be considered when designing augmented and mixed virtual reality systems. Most current approaches are custom designs that offer a limited market penetration due to the difficulty in production, maintenance and cost.

The ultimate challenge is research on the Presence control (inclusion or feeling that you are somewhere different from the real environment). If you want a fully immersive environment, the designer must consider the degree of detail required for the user to believe that the environment is real and not virtual.

For example, returning to the theme of the fear of spiders: a therapist can control a computer-mediated environment if the user is looking to overcome a phobia. In this regard, the U.S. military sponsored research regarding the treatment of post-traumatic stress disorder, based on the Presence.

The science behind Presence is difficult due to the variation of parameters between users and the control of the scene in real time.

Classics like Heeter (1992) may provide a good explanation of the Presence and the various forms it takes .

Conclusion

Augmented and mixed virtual reality systems seem to be moving in many application environments. The research that supports its growth occurs in universities and companies that can commercialize this technology and apply it in specific fields. This paper has presented some examples of research conducted at the University of Central Florida to give the reader an idea of the use of the developed technology and its various applications. This research ecosystem is gaining momentum for the production of this technology and will continue to advance in the future.

Bibliography

Barfield , W. , & **Caudell** , T. (2001). *Fundamentals of Wearable Computers and Augmented Reality*. Lawrence Erlbaum Associates.

Heeter , C. (1992). *Being There : The Subjective Experience of Presence*. Presence :Teleoperators& Virtual Environments .

Milgram, P., **Takemura** , H. , **Utsumi** , A. , & **Kishino** , F. (1994). *Augmented Reality : A Class of Displays on the Reality - Virtuality Continuum*. Proceedings of SPIE ,Telemanipulator and Telepresence Technologies.



Using Simulation in Astronautic and Aerospace Systems

Luis Carlos Rabelo Mendizábal

About the author

Dr. Luis Carlos Rabelo Mendizábal
P.O. Box 162450
University of Central Florida
Orlando, Florida 32816, USA
Luis.Rabelo@ucf.edu

Summary

This article will introduce ideas of simulation and their agents with their applications in the development of aerospace systems and decision making at NASA. In particular, the following topics will be discussed: simulation of new spacecraft (MPCF / SLS and CubeSats) , continuous simulation in the Martian atmosphere , and the use of agents.

General Concepts of Simulation

A model refers to the construction of an abstract model that represents a real life system. The model describes the relevant aspects of the system as a series of equations, relationships, and / or logic statements embodied in a computer program. This series of equations, relationships, and / or logic statements can then be executed. And this last action is simulation!

Simulation models have been successful and effective in representing various functions and designs of Astronautic and Aerospace Systems. This simulation can be performed several ways:

- Discrete Event Simulation: Traditional processes and object-oriented.
- Continuous Simulation: complex differential equations and math used in many models.
- System Dynamics: Developed at the Massachusetts Institute of Technology with a long history, focused on biofeedback.
- Agent-Based Simulation: Emerge in complexity research.

Simulation systems

Simulation systems provide an environment to run simulators / integrated models developed for specific elements of the area of interest. For example, a simulation system for a new spacecraft includes the operations necessary to carry out the launch, conduct

maintenance, and ensure safety. These models would be executed in interactive simulator networks to support a single view of operations. Simulation Systems have to use models of objects and object-oriented methods to practice a hierarchical description of the entities, activities, and interactions represented in integrated models. The Department of Defense (DoD) of the United States and the Institute of Electrical and Electronics Engineers (IEEE) has developed standards for the integration of models [3]. High Level Architecture (HLA) is one of those standards. HLA is used to provide a consistent approach and rules to integrate distributed, heterogeneous, and inherited simulation systems. The HLA has been approved as an IEEE standard (<http://standards.ieee.org/>) and has been adopted as the method for distributed simulation systems by the Object Management Group (<http://simsig.omg.org/>). The software "Run Time Infrastructure" (RTI), which implements the HLA rules and specifications, provides methods that can be called and used by individual federated simulations. RTI interfaces can integrate federal simulations, but the implementation is quite complex.

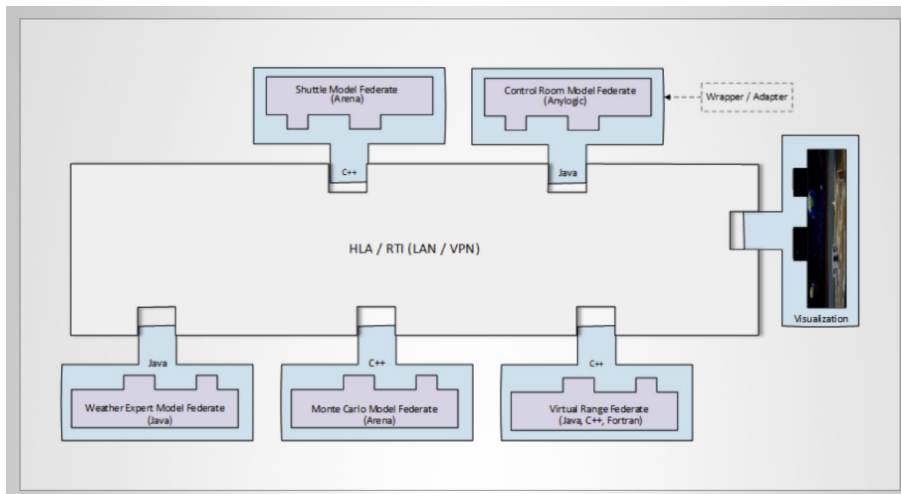

Figure 1. Various continuous simulators and discreet events for simulating the operational life cycle of a spacecraft using HLA.

Distributed and Parallel Processing [7]

Computational environments for these advanced systems for decision making use and parallel distributed processing systems. This is due to the need for computer support that (1) is capable of handling multiple models , (2) supports HLA , (3) is Open Source (to allow modifications) ,

and (4) is a proven system that can be used as the backbone of advanced simulation environments .

Computer systems that assign events on multiple processors to speed up the simulations improves execution time , especially when operating the large number of high speed processors and internal communications that are found in high-performance computing platforms . The object-oriented architecture has a significant impact on the development of these systems. The entities in a system can be represented by individual classes. These representations, in turn, facilitate the distribution of the models on different processors and the design of parallel experiments. Additionally, the distributed environments are run through the World Wide Web.

Discrete Event Simulator for the Operational Cycle of Spacecraft

NASA [8, 9] has announced that the next manned spacecraft will be the MPCV which is based on the design of the capsule of the Apollo Program (Figure 2a). The MPCV and SLS (Figure 2b). Figure 3 is a model of a discrete event simulation to model the assembly of the SLS and MPCV in the VAB building which is also shown in Figure 4. This discrete simulation model was built by consulting experts from NASA and used time / characteristics of the NASA Space Shuttle as a baseline. SLS consists of different modules. These modules should be assembled in the VAB. The following sequences are required for this assembly:

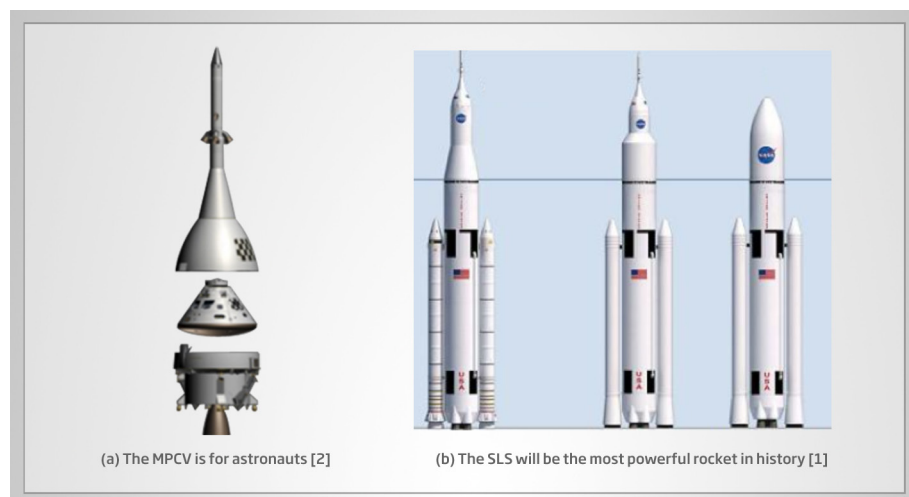

Figure 2. The MPCV and SLS.

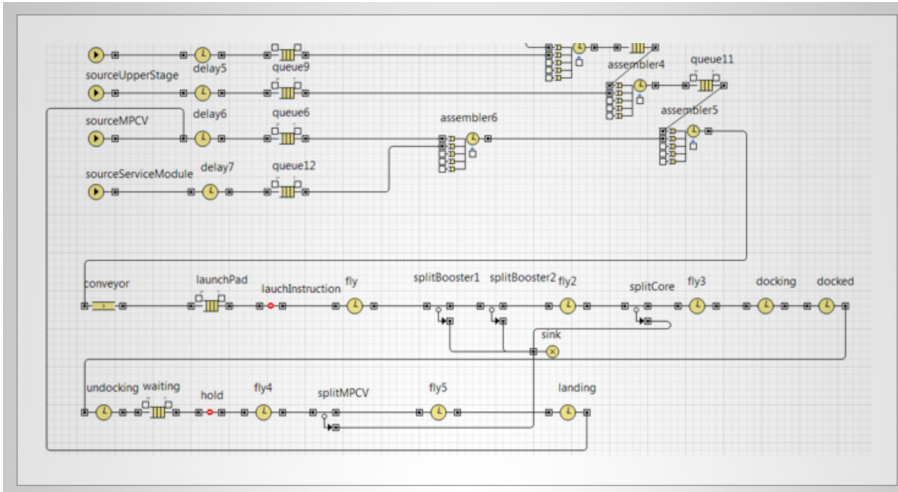

Figure 3. Partial representation of the model for the discrete event simulation for assembly of the SLS and MPCV inside the VAB.

- 1. Phases 1 and 2 of the SLS are transferred to the VAB:** the first phase and the second phase of the SLS arrive at Kennedy Space Center (KSC). They are inspected, then off-loaded and towed to the VAB transfer “island”, where they are stored until they are integrated with the solid rocket boosters (SRBs).
- 2. Solid fuel rockets (SRBs) are assembled in the VAB:** The SRBs are assembled in the hangars of the VAB . Also, parachutes and avionics systems are added to the SRBs.
- 3. Phases 1 and 2 of the SLS are assembled and coupled to the SRBs in the VAB:** This is achieved through cranes which bring the phases into a vertical position at the transfer island, are raised, and are assembled.
- 4. MPCV is integrated in the VAB:** The MPCV is towed to the VAB and placed in the VAB transfer island. A crane is attached to the MPCV and the vehicle is lifted and attached (coupled to Phase 2) to Phase 2 of the SLS and thus completes the spacecraft.

Not only you can make simulation models for CubeSats. A CubeSat is a miniaturized satellite for space research that has a volume of exactly one liter, a mass of 1.33 kilograms, and typically uses industrial electronic components. “Beginning in 1999, the California Polytechnical State University (Cal Poly) and Stanford University developed the CubeSat specifications to help universities

worldwide to perform space science and exploration.”The majority of the development comes from the academia, but several companies have also built CubeSats .



Figure 4. The Vehicle Assembly Building (VAB) was built for the Apollo program (1964). The VAB was designed to store and assemble the 110 meter tall Saturn V rocket. One of the most notable characteristics of the VAB is its 139 meter tall doors (they are the tallest doors in the world). The VAB is also used to mount the NASA Space Shuttle. The VAB is used for the mounting and assembly of the SLS and the MPCV. Photo courtesy of NASA.

Not only you can make simulation models for CubeSats . A CubeSat is a miniaturized satellite for space research that has a volume of exactly one liter, a mass of 1.33 kilograms, and typically uses industrial electronic components. “Beginning in 1999, the California Polytechnical State University (Cal Poly) and Stanford University developed the CubeSat specifications to help universities worldwide to perform space science and exploration.”The majority of the development comes from the academia, but several companies have also built CubeSats .



Figure 5: CubeSats are small satellites used to study space weather and atmospheric changes (Adapted from http://www.nsf.gov/news/news_summ.jsp?cntn_

Continuous simulator to investigate whether microorganisms can survive on Mars

Mars is considered a likely place to find extraterrestrial life for the following reasons:

- Proximity to Earth:
- The presence of Carbon and other essential elements,
- The presence of water.

There are possible sources of energy on Mars that could support microbial proliferation, such as:

- Sunlight,
- Iron ,
- Sulfur ,
- H₂/CO₂.

The current debate is whether terrestrial microorganisms can survive and live on Mars despite the Martian environment where they would be exposed to intense radiation, oxidation and extreme dehydration. This can be verified by creating continuous simulators

that simulate the microorganisms and their DNA and their exposure to the Martian environment. The Martian atmosphere can be described in mathematical way and the chemical reactions can be described.



Figure 6: NASA engineers examine the heat shield of the “Curiosity Rover” and check its cleaning. Photo courtesy of NASA [6].

Simulation with Agents to study human resources for the Space Program

Agent-based models are able to capture certain features that are not possible with discrete and continuous event models. In this simulation there are two types of agents. One type of agent is the employer (e.g., NASA KSC) and other agent is the employee (for example, a NASA engineer) [4]. The agents are implemented using AnyLogic (<http://www.anylogic.com/>). AnyLogic provides a “Class” called an “Active Object”. Active objects can be used to model employees and employers. Employees are modeled by a discrete

event system with the support of state diagrams. Employees move from one state to another based on the decisions made by the agents (e.g., training) and / or interactions with the environment. These agents can share states and resources with other employees. Furthermore, an active object is derivative of a class of active objects. Active objects such as an “Employer” may encapsulate other active objects to any desired depth.

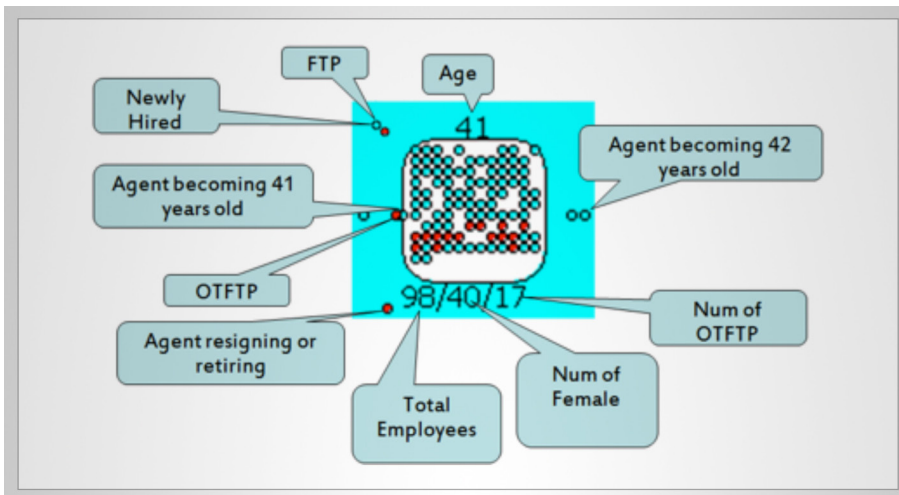

Figure 7: Animation of the engineers who are 41 years old.

According to Figure 7, there are 98 engineers with 41 years of age, 40 of the 98 are women, and 17 of the 98 are on temporary contracts. In another dimension, one can visualize the area of specialization and the corresponding level of experience.

Therefore, the modeling of the individual productivity of engineers and their teams to achieve different objectives of the program / project can be achieved using agents. The different areas are based on the engineering needed to carry out the transformation of the Space Center of the Space Shuttle to a Launch Center for the MPCV / SLS.

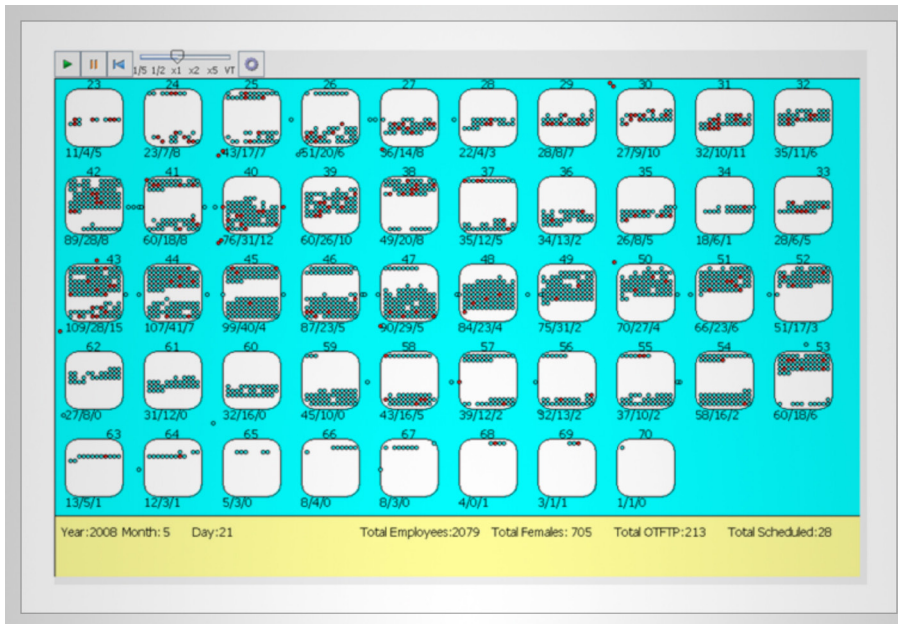

Figure 8: Representation of all simulated labor of the NASA Kennedy Space Center at a determined moment (May 21, 2008). There are different blocks of employees, aged 23 to 70 years old (2079 employees).

Conclusions

Simulation is one of the most important areas for space exploration. The Office of the Chief Technology Officer (OCT) of NASA [5] has stated that “simulation focuses on the design, planning and operational challenges of the distributed and long term NASA mission systems.” We agree in that the model represents the characteristics of a system from a one dimensional or multidimensional viewpoint. On the other hand, the simulation is the execution of a model that has the potential (if the model is able to adequately capture the characteristics to a certain level of fidelity) to represent behavior. In addition, the OCT Office tells us that “Through the combination of the two, we can make better decisions and communicate decisions early in the design and development process when changes are easy and quick, rather than during production when they are very expensive and almost impossible”. For this reason simulation is very important for Astronautical and Aerospace systems.

References

1. **Bergin** , C. (2012) . Dynetics and PWR aiming to liquidize SLS booster competition with F - 1 power . <http://www.nasaspaceflight.com/2012/11/dynetics-pwr-liquidize-sls-booster-competition-f-1-power> .
2. **Eddy** , M. (2011) . A Closer Look at NASA 's Multi -Purpose Crew Vehicle. <http://www.geeko-system.com/nasa-mpcv-infographic/> .
3. **Judith** , D., **M. Richard** and **M. Richard** (1998). *The DoD high level architecture: an update*. 1998 Winter Simulation Conference Proceedings (Cat.No.98CH36274) , 797-804 .
4. **Marin** , M. , **Y. Zhu** , **P. Meade**, **M. Sargent** and **J. Warren** (2006). "*System Dynamics and Agent -based Simulations for Workforce Climate*," Proceedings of the 2006 Winter Simulation Conference , 667-671 .
5. NASA Office of the Chief Technologist (OCT) (2010) . DRAFT Modeling , Simulation , Information Technology & Processing Technology Roadmap http://www.nasa.gov/pdf/501321main_TA11-MSITP-DRAFT-Nov2010-A1.pdf Area 11 .
6. **Matson** , J. (2013). "*Can Thrive Hitchhiking Earth Microbes on Mars ?*," Scientific American .
7. **Rabelo** , L. (2003). "*Advanced Environments for Decision Making*," Digital Policy , Nexus Publishing , Vol 12, pp. . 14-18.
8. **Rabelo** L. , **Y. Zhu** , **J. Compton** and **J. Bardina** (2011) . "*Ground and Range Operations for a Heavy -Lift Vehicle : Preliminary Thoughts*," International Journal of Aerospace , Vol 4, No. 2 , 1064-1073 .
9. Review of U.S. Human Spaceflight Plans Committee (2009) . Seeking a Human Spaceflight Program Worthy

First stage of Project KID (CID)/ALFA III in Tapachula , Chiapas, Mexico

Susana Maria Sosa Silva

About the author

Susana Maria Sosa Silva
Full time professor at the Autonomous University of Chiapas
General Coordinator of the Virtual University
Email: ss.susana@hotmail.com
Boulevard Belisario Dominguez, Km. Tuxtla Gutiérrez, Chiapas.

Abstract

The following article presents the first part of the implementation of the KID(CID) Project ALFA III, which has as an objective the social integration of typically excluded groups. The application of the project in Mexico is held by ANUIES and in Chiapas by the Autonomous University of Chiapas (Universidad Autónoma de Chiapas – UNACH). The methodology proposed by the European Union was applied in the municipality of Tapachula de Córdova y Ordoñez, in the state of Chiapas, where the KID Committee is located and the Pact for Learning and Knowledge was established.

Keywords: ALFA KID, social integration, Chiapas.

Background

The ALFA Program in Latin America

Since 1994 the ALFA program began strengthening cooperation operations between two regions, Latin America (LA) and the European Community (EC). Three phases were established:

The first phase, ALFA I (1994-1999), with an EC contribution of € 31m was developed until 1999, involving 1064 institutions operating 846 micro-projects.

The second phase, ALFA II (2000-2006), with a total of 10 selection rounds, was represented by an EC contribution of € 54.6m distributed to 225 approved projects undertaken by 770 institutions divided into networks with an average of 9 institutions from Latin America and from the EC.

The third phase, ALFA III (2007-2013), is endowed with a budget of 85 million euros. ALFA III represents a significant increase in its budget in terms of the contribution of the European Union, but it also constitutes a new and improved program structure, consisting of 3 specific lots: Lot 1- Joint projects, Lot 2- Structural projects, Lot 3 –Accompanying measures. (European Commission, 2012)

Within the priorities suggested for this program is the reform of institutions of higher education and their programs, from which quality human resources are expected to develop. Among others, it is contemplated that this would result in the creation of a shared space for Higher Education in Latin America through three types of projects:

a) Joint Projects (Lot 1)

Exchange of experiences, methodologies and knowledge

Topics: Institutional management / Academic Management / Technical and Scientific ; Social Cohesion.

b) Structural Projects (Lot 2)

Reforms , modernization, harmonization of educational systems
Topics: Modernization of Higher Education Systems in LA and social cohesion .

c) Accompanying Measures (Lot 3)

Creating synergies, coordination between projects and components

Topics: Regional visibility / regional program awareness, best practices, exchange of experiences, coherence/ coordination / synergy of components (European Commission , 2012).

In the case of Latin America, ALFA III's specific objective is "to promote higher education (...) as a means to contribute to economic and social development of the region." (European Commission, 2012). As part of these strategies to support higher education, as mentioned in the rubric " Structural projects " , is the KID Project : Knowledge - Inclusion - Development (KID) cooperative strategy between higher education institutions in countries such as Argentina , Bolivia , Brazil , Chile , Colombia , Costa Rica , Cuba , Ecuador , El Salvador , Guatemala , Honduras , Mexico , Nicaragua , Panama , Paraguay , Peru , Uruguay and Venezuela , and the nations that form the European Union .

With this in mind, it is intended that the experience of universities contribute to the "local development , access to university education and especially continuing education for socially disadvantaged persons ." (ANUIES , 2011) . This work focused on the integration of Compact for Learning and Knowledge (CLK) in which three actors merge: universities, industry and social sectors of America and The Caribbean. (Figure 1)

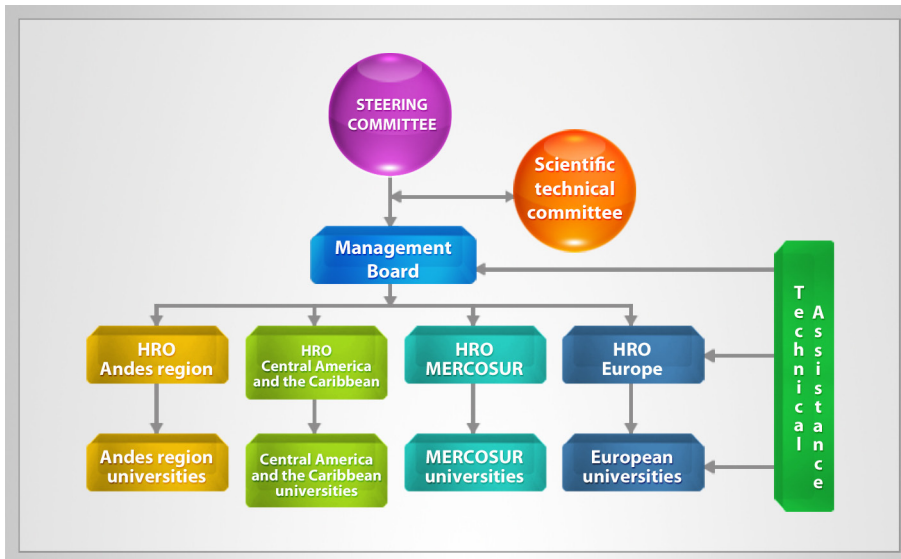

Figure 1. Various continuous simulators and discreet events for simulating the operational life cycle of a spacecraft using HLA.

This systemic perspective of social integration contains various objectives, which include: rethinking the role and educational programs offered by the universities, and integrating specific sectors - men over 40 and unemployed women - into the workforce and thus meet the needs of industry and business in the region. The fundamental concepts are considered from the following definitions:

Knowledge as a key fulcrum for the emancipation of social and economic development;

Inclusion as an objective of economic democracy, participation and active citizenship

Development as the purpose of well-being and sustainable progress. (Carapella , S. F.)¹

KID Project in Mexico

The KID Project began in Mexico in 2011 with the determination to execute it (with resources and methodology) through the National Association of Universities and Institutions of Higher Education (ANUIES). Traditionally, the project in Europe and

in other American nations such as Argentina and Colombia , operates directly through a university applying the installation methodology of the CLK. Due to some particularities of Mexico such as the pre-election context of 2012 and the socio-economic nature of its municipalities, the project does not operate in major universities in the nation. Rather, they choose to work with those that meet the following characteristics:

- IHE that are in states that meet the highest percentage of low-income population (according to 2010 Census data)
- Are public institutions of higher education (IHE) whose campus supports the greatest number of enrolled students.
- Are IHE's linked to their environment through continuous service projects as much as knowledge, such as helping their populations. (ANUIES , 2011)²

Computer systems that assign events on multiple processors to speed up the simulations improves execution time , especially when operating the large number of high speed processors and internal communications that are found in high-performance computing platforms . The object-oriented architecture has a significant impact on the development of these systems. The entities in a system can be represented by individual classes. These representations, in turn, facilitate the distribution of the models on different processors and the design of parallel experiments. Additionally, the distributed environments are run through the World Wide Web.

In addition to previously mentioned characteristics, other features are sought out such as the appropriate technological infrastructure for establishing networks of knowledge and experience in community work. The KID Project was initially established in the states of Puebla ,

¹ Bruno Caparella points out the relevance of such a project that “ In Latin America , a place of great cultural fervor and systemic fragility of its territories , the model of development based on knowledge and knowledge as a competitive factor appears sustainable, sound , intuitive “ .

² ANUIES has among its members 164 public and private institutions of higher education throughout Mexico as of April 2012 .

Veracruz , The State of Mexico and Chiapas . It currently only operates in Veracruz , the State of Mexico and Chiapas . (Figure 2)

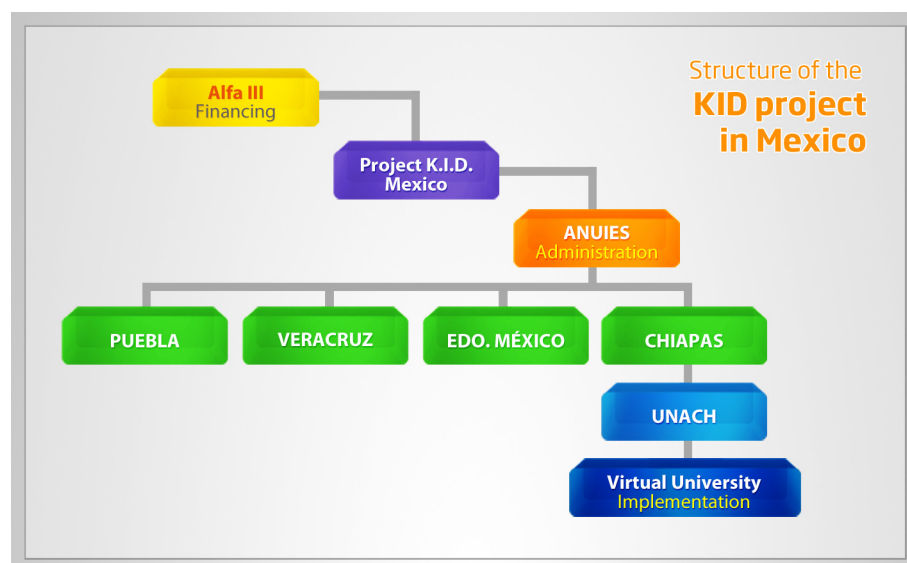

Figure 2. Structure of the KID project in Mexico.

Additional objectives emerge from the general objective of the KID Project, such as:

- Disseminate a model of social cohesion [...] based on the needs of the territory and needs of the target groups.
- Improve the location of universities within the framework of local development policies and social cohesion [...]
- Plan [...] training interventions that respond to the characteristics of the target groups and alternating systems between the university, family and work ; promote equal opportunity policies in the territory.
- Strengthen the capacities of universities [...] with respect to the needs of the territory.
- Build networks among higher education institutions of Latin American and Caribbean countries and Europe, and promote the establishment of a Community of Work and Learning [...] . (Carapella , S. F.)

Methodology for the implementation of the CLK

The previously mentioned objectives are consistent with the proposed methodology for the integration of the CLK. Beginning with the presentation of the project and the appointment of the venues, the first phase consists of integrating a KID committee, which will consist of higher education institutions in the region, entrepreneurs, general employers, institutions that represent the local government, as well as nongovernmental organizations (NGOs).

This Committee has among its functions guiding the project until the establishment of the CLK. The committee ensures that all of the voices included from the social sectors are represented in the decisions of the CLK, as will be explained later. The next phase is the implementation of a diagnosis of the specific target populations, in order to know the educational and training needs first-hand from residents and employers in order to design a relevant and tailored offer. This same diagnosis will serve to observe current educational programs.

Upon completion of the previous phases, we proceed to the signing of the CLK, which will be explained more fully hereinafter, but consists of a series of commitments and policies that will direct training actions for the given population. Finally, the training is conducted and with the above result, the educational programs offered by the IHEs are revised so that there was a real link between University and Society. Figure 3.

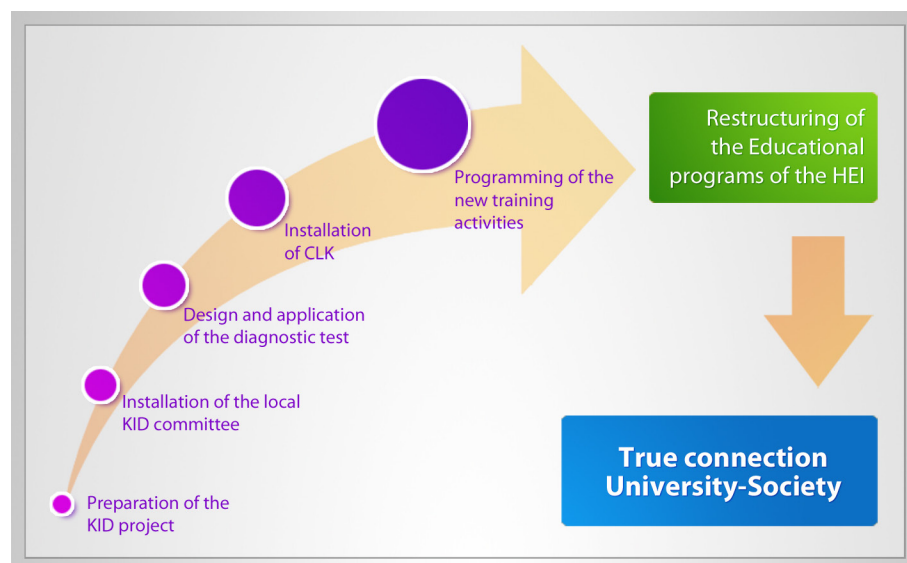

Figure 3 (reevaluation of the Educational programs of the IHE)

Application of the methodology CID ALFA Project in Chiapas

The operation of the KID Project in Chiapas, is at the hands of the Autonomous University of Chiapas, and is coordinated by the Virtual University given the need for technological infrastructure , and shared with other participating IHE's in the country , which lies mainly in the administration of the SINED Node³

It was determined to implement Project KID in the border municipality of Tapachula , located in region VIII /Soconusco, in the State of Chiapas , in the colonies of Cafetales (3, 054 inhabitants) and A Better Life (6,460 inhabitants) . These areas were chosen due to the vulnerable groups located in the communities that express significant social under development according to the National Council for Evaluation of Social Development Policy (CONEVAL). This is due to the nature of its population which was relocated after the disaster caused by Hurricane Stan in October of 2004 (inhabitants from 32 out of the 59 affected colonies make up the study population).

Social underdevelopment indicators in both colonies

a. Installing the KID Committee (Indicators of social underdevelopment in both colonies;)

On October 11, 2012 , A KID Committee was installed as one of the first phases of the Project KID Committee Tapachula , being established according to the specifications of the inter -institutional Model of

³A SINED node is an area of human activity whose interconnections form a network; it has the function to support, advise and train individuals, educational institutions, research centers, development and business in the region, and is responsible for the detection of educational needs , identify leaders and niche opportunities that generate knowledge and incorporate them into the network of networks of SINED. Nodes are then presented as spaces for articulation of social-educational and cultural activities with the objective of strengthening the links between all stakeholders in the SINED , enhancing interaction and communication in the framework of the various proposals and distance education projects . (http://www.sined.mx/sined/nodo_sined/nodos.php)

Operation and Management Committee whose administration falls under the UNACH.

Indicators of social underdevelopment in both colonies		
Cafetales	2005	2010
Total population	365	3,054
% of the population 15 years old or more who are illiterate.	2.98	3.2
% of the population between 6 to 14 years old who do not go to school.	9.62	4.74
% of the population 15 years or older that have incomplete basic education.	29.18	32.36
% of the population without healthcare.	26.3	31.6
% of the homes with dirt floors.	0.96	3.73
% of the homes without a bathroom or toilet.	3.85	0.11
% of the homes the do not have a connection to the public water system.	0	65.08
% of the homes that do not have a sewage connection	0	0
% of the home that do not have electricity.	2.88	0
% of the homes that do not have a washing machine.	55.77	50.73
% of the homes that do not have a refrigerator.	19.23	9.49
Index of social underdevelopment	-1.46937	-1.15053
Grade of social underdevelopment	1 muy bajo	Muy bajo
Place occupied in the national context	0	0
Vida mejor	2005	2010
Total population	16	6,460
% of the population 15 years old or more who are illiterate.	22.22	10.68
% of the population between 6 to 14 years old who do not go to school.	50	8.06
% of the population 15 years or older that have incomplete basic education.	100	47.4
% of the population without healthcare.	75	42.18
% of the homes with dirt floors.	0	1.16
% of the homes without a bathroom or toilet.	0	0.17
% of the homes the do not have a connection to the public water system.	100	0.46
% of the homes that do not have a sewage connection	0	0
% of the home that do not have electricity.	0	0.06
% of the homes that do not have a washing machine.	100	46.67
% of the homes that do not have a refrigerator.	66.67	10.67
Index of social underdevelopment	0.02509	-1.12149
Grade of social underdevelopment	3 medio	Muy bajo
Place occupied in the national context	0	0

Source: CONEVAL estimates, based on INEGI, II Population and Housing 2005 and 2005 ENIGH.
CONEVAL estimates based on the Census of Population and Housing 2010

Table 1.

- A. UV - Autonomous University of Chiapas (President)
- B. TecMilenio Institute of the Tecnológico de Monterrey System
- C. Por la Superación de la Mujer A.C.
- D. H. City of Tapachula
- E. Institute for Women, H. City of Tapachula
- F. Delegation from the colony Cafetales
- G. Delegation from the colony A Better Life
- H. GalatasFoundation A.C.
- I. Ministry of Labor and Planning
- J. Chamber of Commerce and Tourist Services
- K. Mexican Employers Confederation
- L. Technological Institute of Tapachula

The Committee is formed by representatives from higher education institutions, the public sector, civil society organizations and the productive sector, which is entrusted to implement and evaluate the CLK.

b) Design and implementation of diagnosis.⁵

We conducted an observational type study-intervention, prospective, longitudinal – for which three instruments were designed in order to know:

- a. The socioeconomic status of the population and their training interests.
- b. The training needs of the business sector.
- c. The profiles offered by institutions of higher and technical education.

The questionnaire was administered to the population of both colonies, and consisted of 54 reagents which were distributed as follows: Module I, General data with 22 questions ; Module II , Employment with 21 questions and Module III, health . The study was conducted in both colonies selected in a period between October and December 2012. Data collection lasted one month , from November 19 to December 19, 2012 .

⁵The diagnosis was provided by the officials of KID project in Mexico , however it is appropriate to each region according to their own needs .

The population that composed the study was made up of men and women from the colonies Cafetales and A Better Life ; women aged 16 to 17 with parental permission and those older than 18 years of age ,and men over 40 who were unemployed or underemployed.

The data was collected in four stages: an informative visit to the selected colonies, the identification of randomly chosen blocks and land for application of the instrument; visits to businesses and chambers of commerce in order to know job profiles required by its affiliates, and finally in the fourth stage visits to institutions of higher and technical education, in order to know the training offered in the locality.

Initial Results

The results presented below are not the overall results of the diagnostic tool. They are presented in part those that directly impact the establishment of the ALK; in other words the data refers to notable areas such as: education, productive activities and educational opportunities.

Characteristics of the population of the colony Better Life

Male population

Level of education	Percentage
Basic education	22.58
Illiteracy	1.61
Learned by not exercised productive activities	Percentage
Carpentry	26
Electricity and construction	16
Reason for unemployment	Percentage
Lack of studies	39
The jobs are not in according to their studies	17
Age	13
Lack of vacancies	9

Table 2.

Percentages in training desired by the population:

Course	inhabitants	%
Carpentry	20	38
Cooking	1	2
Computing	3	6
Electrical installation	3	6
Equipment maintenance	16	30
Mechanics	1	2
Plumbing	7	13
Services	2	4

Table 3.

Female population

It was found that 30 people were under 18 years of age with an average age of 17 , and 207 were older than 18 with an average age of 36.

Level of education	Percentage
Level of basic education	27
Illiteracy	0.4
Learned by not exercised productive activities	Percentage
Cooking	30
Sales	15
Reason for unemployment	Percentage
Lack of studies	18
The jobs are not in according to their studies	24
Age	10
Lack of vacancies	32
Incompatibility with the schedule	16

Table 4.

Of the female population that was surveyed, 55% had interest in the following training:

Course	Inhabitants	%
Administration	1	0.8
Handcrafts	1	0.8
Beauty	11	8.5
Embroidery	1	0.8
Cooking	63	48.5
Computing	7	5.4
Accounting	1	0.8
Tailoring and dressmaking	2	1.5
Creativity	1	0.8
Babysitting	1	0.8
Nursing	37	28.5
Equipment maintenance	4	3.1
TOTAL	130	55%

Table 5.

Characteristics of the population of the colony Cafetales Male population

Level of education	Percentage
Level of basic education	32
Illiteracy	2
High school	2
Learned but not exercised productive activities	Percentage
Sales	46
Ecology and recycling	2
Reason for unemployment	Percentage
Lack of studies	12
Incompatibility with the schedule	7
Lack of vacancies	81

Table 6.

The 63 % (27 people) of the male population said they would like to be trained in :

Course	Inhabitants	%
Carpentry	6	22
Equipment maintenance	13	48
Mechanics	3	11
Electrical installation	5	19
Total	27	100

Table 7.

Female population

Level of education	Percentage
Level of basic education	30.4
Learned but not exercised productive activities	Percentage
Cooking and cleaning	28
Handcrafts and beauty	10
Reason for unemployment	Percentage
The job does not correspond to their studies	24
Age	10
Incompatibility with the schedule	32
Lack of vacancies	16

Table 8.

Of the surveyed population, 61 % (80 people) would like to have the following training :

Course	Inhabitants	%
Administration	1	1.25
Beauty	11	13.75
Embroidery	1	1.25
Cooking	30	37.5
Computing	5	6.25
Tailoring / Dressmaking	2	2.5
Nursing	30	37.5
Total	80	100

Table 9.

Partial cross of the results

The similarities and differences of formation of interest in the population of the colonies Cafetales and A Better Life are:

Male population				
Colony	Carpentry	Equipment maintenance	Electrical installation	Plumbing
Cafetales	22%	48%	19%	0%
A Better Life	38%	30%	0%	13%

Female population			
Colony	Beauty	Cooking	Nursing
Cafetales	13.75%	37.5%	37.5%
A Better Life	8.5%	48.5%	28.5%

Table 10.

Analysis of current training supply and demand

The analysis of the HEI's of Tapachula reveals that this municipality has institutions that offer professional studies and others which are dedicated to scientific and technical studies .

IHE. Offer professional studies (disciplinary rubrics)	IHE. Offer technical and scientific programs (disciplinary rubrics)
Education and humanities Social sciences Administrative science	Engineering Technology

Table 11

c) Configuration of the CLK

Once applied, the diagnostic test referred to in the previous point and the methodology was established. We then proceeded to the signing of the CLK . The Compact for Learning and Knowledge (CLK) is one of the tools to establish a more suitable link between universities and local production systems , which direct and supervise the activities as an evaluation and implementation of the decisions taken by the KID Committee .

This direction will come as “policies, projects and practices that must be defined by a strong involvement of social actors and institutions operating in the territory (business associations , trade unions, local governments, NGOs , women’s association etc. .)”(Carapella , nd)

The CLK meets objectives such as : increasing the positive impact of local development initiatives , program the training in a more relevant and inclusive manner for all sectors of society, and provide support for the transformation of local instruction systems especially higher education. It is important to clarify that in the case of Latin America and specifically Mexico, there are some variations as attention should focus on the lower levels of education and have a matrix closer to continuing education. Therefore, the offer of regional training will be located in these terms which are not specific to higher education.

Competencies required for the economic sector	Institutions that provide these competencies	Competencies requested by the public
<ul style="list-style-type: none"> • Diesel motor repair • Refrigeration • Carpentry • Electrician • Basic knowledge of English • Metal smithing • Customer service/attitude and dedication • Use of heavy machinery • Responsibility • Values and ethics • Money exchange (peso-quetzal-dollar) • Process knowledge • Commercialization 	CONALEP CECATI ICATECH Social Security Center of the IMSS UNACH	Nursing Cooking Beauty Carpentry Equipment maintenance Plumbing Mechanics Sales Small business administration

Table 12

Conclusions and methodological prospective

d) Regional Training Plan (RTP)

Once the statistical information was processed and analyzed regarding the common ground between society, business and HEI's, the following was determined as the final result of this phase of the KID ALFA Project to date:

1. Provide 6 programmed courses in :
 - a) Food preparation
 - b) Beauty and personal hygiene
 - c) Health education and first aid
 - d) Carpentry
 - e) Cooling/refrigeration
 - f) Small Business Administration

2. Train a total of 60 people from the project focus groups .
3. The education workshops for health and first aid, beauty and personal hygiene correspond to the Social Security Center of the IMSS .
4. The courses in small business administration, carpentry, food preparation, and in the case of developing courses in maintenance and refrigeration correspond to the ICATECH.
5. Follow up on the training activities through continuous evaluation.
6. Record the experiences that were shared within the themed networks from the KID ALFA project.
7. Based on the previous information, record and publish a compendium of experiences of the participants .
8. Design an adequate space in the "Ignacio Zaragoza" primary school for the children of the mothers who participate in the "Beauty and personal hygiene and Health Education" course.
9. The Federal Labor office offered that once the training courses were finished, the institution would give a document that supports the training of those who were enrolled in the workshops.
- 10 . All of institutions involved in this committee promise to disseminate the results of the project through the means at their disposal .
11. Based on the request made by the various participating organizations to include the issue of values in training, the social Security Center IMSS offered to include the subject of human values in their courses.
12. Minors (5 to 15 years) of mothers will have a day care program with productive, scholastic, and craft activities, as well as sports during the training schedule.

In summary, up to this point achievements have included: the installation of the KID Committee, the application of the diagnostic test, and the establishment of the CSK .It will be determined in which

of the following phases the PFT should be applied and yield results that will allow for the redirecting of educational programs of the institutions that form the KID Committee.

References

Association of Universities and Institutions of Higher Education. (2011) . ALFA CID III Mexico .In Mexico Cid Project 2011-2013. ALFA III Programme . [Online] .
<http://alfacid.anuies.mx/?page=cidmexico>

Association of Universities and Institutions of Higher Education. (2011) . Cid Mexico Project 2011-2013. ALFA III Programme . [Online] .
<http://alfacid.anuies.mx/?page=crui>

Carapella , Bruno . (S. F.) CID Project .Knowledge , Inclusion and Development . Compact for Learning and Knowledge (PAC) . [Online] .
http://alfacid.anuies.mx/pages/docs/Pacto_para_el_aprendizaje_y_el_conocimiento.pdf

European Commission. (2012) . EUROPEAID Cooperation and Development . [Online] .
http://ec.europa.eu/europeaid/where/latin-america/regional-cooperation/alfa/detail_es.htm

National Council for Evaluation of Social Development Policy . (2005).

Analysis and measurement of poverty .[Online] .
<http://www.coneval.gob.mx/medicion/Paginas/Medici%C3%B3n/Pobreza-2010.aspx>

Fundazione CRUI (S. F.) Gobernance . CID In Project , Knowledge Inclusion Development . [Online] .
<http://www.alfacid.fondazionecrui.it/Paginas/Governance/default.aspx>

National System of Distance Education . (2012) . Nodes. [Online] .
http://www.sined.mx/sined/nodo_sined/nodos.php

Measuring the attitudes of college students towards the use of ICT

Martha Patricia Astudillo Torres
Florlenis Chévez Ponce

About the authors

Martha Patricia Astudillo Torres is Doctor in Education from the University of Costa Rica, scholarship grantee from the Autonomous University of Chiapas and the Nacional Council on Science and Technology of Mexico; she has published academic articles in journals and has participated in national and international congresses regarding ICT in higher education.

Email: patricia.astudillo@unach.mx

Florlenis Chévez Ponce is a Doctor in Education from the University of Costa Rica, is trained as a national adviser in the Department of Academic Evaluation and Certification in the Direction of Evaluation and Management of Quality of the Minister of Public Education of Costa Rica. She is also a professor at the National University of Costa Rica.

Email: florlenis@gmail.com

Abstract

This article presents the analysis of the attitudes of the student body of the Engineering Department in relation to the use of Information and Communication Technologies (ICT's) in their academic context as well as in daily life. To achieve this, two questionnaires were applied using the Likert structure. The results were analyzed in the light of using the Classical Test Theory. The principal findings indicate that the students favorably accept the use of ICT's in both contexts.

Keywords: ICT, attitudes, university students, Classical Test Theory

Introduction

This paper aims to analyze the attitudes of students towards the use of Information and Communication Technology (ICT) in the School of Engineering at the Autonomous University of Chiapas, Mexico, in order to infer by empirical methods representations expressed by the students in the use of ICT, both in their academic activities and in their everyday life.

Knowing these attitudes allows educators to build and / or rebuild innovative and transformative teaching and learning methods that are in line with the tendency of the students to act or react- in this case with ICT, in order to improve the quality of the learning process. In order to do this, it is necessary to incorporate new resources and strategies which integrate these technologies into learning environments to support the active process of building knowledge and the development of skills that favor the effectiveness and efficiency of training models (Marcano Marcano, N. & Araujo, 2007).

To fulfill the purpose of this investigation, we designed and implemented a quantitative scale to a representative sample of the study population. A social desirability scale (developed by Montero in 2006) was also applied to measure the bias of the informants. Similarly, we made use of qualitative analysis techniques to establish the theoretical foundation of the study.

In the first part of the document, the methodology used in the investigation is presented, followed by the definition and theoretical underpinnings of the construct, results and finally conclusions.

Methodology

The study is a quantitative approach that uses two scales to measure students' attitudes towards the use of ICT in both the educational context and in everyday life, and the bias of informants through a social desirability scale. We also used literature review and content analysis to support the theoretical framework of the investigation and interpret the statistical results that were obtained.

The sample size was selected based on the usual criteria of a confidence level of 95 % (two sigmas) and an estimation error or sample error of 5 % (Arnal , Del Rincón & Latorre , 1992) . To do this, we used the formula for calculating a sample size for a finite population. From a total of 800 students of the Bachelor program in Civil Engineering, we obtained a sample of 267 students.

To validate the content of the questionnaire called "attitudes of engineering students towards the use of ICT", an expert panel discussion procedure was used where two or more experts are selected to independently judge the validity of the answers on the questionnaire in terms of relevance or congruence of the reagents with the context of the content, the clarity of the writing and the trend or bias in information obtained from the questions (Ruiz, 2011) . The data analysis was conducted from the TCT and was performed using the data program SPSS, version 16.

Definition and theoretical foundation of the construct

Starting from the purpose of the investigation, we defined a construct that measures attitudes towards the use of ICT for college students, both in their educational context and their daily lives. In this construct students perceptions, beliefs and likes are considered with regard to ICT in 4 variables: perception of ICT in academic and daily life, perception of ICT in classes, and perceived institutional technology infrastructure and perception of ICT by teachers. These variables are registered by 29 items that use the Likert scale , which " consists of a series of items or statements about a specific objective where the respondent has to report their level of agreement or disagreement " (Colas & Buendia , 1998, p. 216). Similarly, the Likert scale is the most frequently used attitude scale because they acquire high levels of

reliability with fewer items or questions (Morales, 2000). In this sense, Hernández, Fernández and Baptista (2006) point out that the only basic assumption is that the response is noted in each item depending on the subject's position in the continuum of the measured variable, i.e., greater agreement implies that the subject has more of the measured trait .

In a similar manner, this construct is within the category of feelings and affective dimensions: beliefs and attitudes. According to Moscovici (1988) attitudes are a set of beliefs, feelings and tendencies of an individual that lead to a certain behavior. Attitudes have several components: the cognitive component, which are the beliefs, values and stereotypes about the object of the study; affective component, which intertwines the feelings and emotions that come with the varying frequency of the attitude; and tendency or behavioral trend that has to do with the tendency to act or react in a certain way with respect to the object of study (Munne , 1986) , which in this case is the attitude in the use of ICT in university students.

Based on the previous information, it is considered that attitude can be measured through opinion, which is represented through verbal expression. You could not access the attitude of people directly and solely by observation. It is necessary that the verbal opinion expressed by subjects serve as their indicator of attitude. If you get an indication of acceptance or rejection of opinions, you indirectly obtain a measure of their attitudes (Ospina , Sandoval , Aristizabal & Ramirez , 2005) , which corresponds to the purpose of the construct developed in this investigation .

It is important to note that for this study, attitude is defined as the perceptions, beliefs and interests that students have towards the use of ICT, both in their academic activities and in their daily lives.

It is also considered important to study the attitudes of students in the use of ICT , due to the understanding that their inclusion in the educational context is framed by the attitude the students and teachers have to the introduction of such technological tools. In other words, technologies can be included in the classroom by teachers and students as long as they want to use them. The personal component represents a very important role because the cognitive, affective and behavioral aspects can be displayed in the management of these technological tools , and it is under this parameter of beliefs that the assessment of emotions and behaviors can determine an attitude of acceptance or rejection (Marcano, Marcano N. & Araujo . , p . 2007) .

The social desirability scale developed by Montero in 2006 is comprised of 10 items. These types of scales try to measure the positively biased descriptions that the informants make to assess their preferences on the subject of interest, which in this case are attitudes towards the use of ICT in the context of education and everyday life. Social desirability, according to Ledesma, Forestry & Poó "is a factor that can affect the validity of self-reports. For this reason, it is necessary to evaluate its presence and possible effects." (2010, p. 299)

The results of these scales are analyzed in light of the Classical Test Theory. This theory describes the influence of measurement errors in the observed scores and their relationship to the true scores. This model assumes that certain assumptions are true, and if these beliefs are reasonable, the results are likely to be as well. Otherwise it will lead to false conclusions (Martinez, 2005).

Two very useful concepts in the analysis of results are their validity and reliability. In this sense, Messick (1980) indicates that when it comes to validity, the validity of the construct is the one that integrates the considerations of content validity and the criteria of a common framework for testing hypotheses about theoretically relevant relationships. In addition, there is the valuable contribution that validity gives in terms of the consequences in the use of the information.

Regarding reliability according to Muñiz (2003), this measure is considered reliable from a coefficient of 0.80, which reflects the degree to which the items that make up the test would fit. Therefore, it is considered an indicator of the internal consistency of the test.

Results

Based on the statistical analysis, the results indicate that the scale called "Attitudes of engineering students towards the use of ICT" has a Cronbach's alpha index of .895 and social desirability scale value of .807. This shows that the internal reliability that the instruments possess are within the parameters established for educational research.

The correlation between these scales is determined using the Pearson correlation. The value of this coefficient is .053, which means that there is a significant linear relationship between the scales of "Attitudes towards the use of ICT and social desirability". In other words, there is no correlation between the variables of both instruments.

An argument for the poor correlation between the scales could be the lack of interest on the part of respondents to answer the social desirability questionnaire because it was applied after answering the 29 items corresponding to the attitude scale. However, the instruments have the necessary validity needed to collect the information from the study.

Also, the descriptive analysis of the scale of students' attitudes, which is the focus of this investigation, indicates that of students between 18 and 29 years of age, 22.5% are women and 77.5 % men, and they are enrolled in the pre university period or in high school and the first, fourth, fifth, sixth, seventh, eighth, ninth and tenth semesters of the Bachelors program in Civil Engineering.

Table 1 shows the gender distribution of the students.

		Frequency	Percent	Valid Percent	Cumulative Percent
Valid	woman	60	22.5	22.5	22.5
	Man	207	77.5	77.5	100
	Total	267	100	100	

Table 1. Distribution of student gender. Source: personal (2013)

Regarding perceptions of ICT in academic and daily life, most students consider that they have the skills to use ICT both in their academic activities and in everyday life. In reference to academic activities, they believe that ICT's help to supplement their education, improve their academic performance , speed up the development of their tasks, facilitate and enhance learning, and provide valuable elements for independent learning . Similarly, students think that ICT's facilitate the search of information for academic work, are a means to foster personal relationships with their classmates, and are interested in taking courses in ICT for their areas of study.

The use of ICT in everyday life manifests itself by the interest in using computers in habitual activities, as well as when considering that these technologies have favorably changed their daily lives. The previous statement can be seen in Table 2.

Item	Strongly Disagree	Disagree	Unsure	Agree	Strongly Agree
1.- I have the necessary preparation to make use of ICT's for my academic activities.	4	9	57	135	62
2.- The ICT's help me as a compliment to my learning/knowledge	3	7	12	118	127
3.- The ICT's help me to improve my academic results	0	8	33	140	86
4.- The ICT's allow me to refine the preparation of homework	2	4	24	96	141
5.- I have taken classes through ICT	38	53	77	72	27
6.- ICT's facilitate and improve my learning.	2	9	35	158	63
7.- The ICT's provide valuable elements for my independent learning	2	10	37	138	80
8.- I enjoy my academic activities using ICT.	3	17	51	121	75
9.- The ICT's are a help when searching for information for my academic activities.	1	5	20	120	121
10.- The ICT's are a useful tool in the elaboration of my academic work.	1	3	20	139	104
11.- ICT's are an essential aid in my studies.	7	16	64	136	44
12.- I welcome the inclusion of ICT's in my educational context.	2	11	45	148	61
13.- I'd like to take courses on ICT for my area of study.	3	5	22	89	148
14.- I want to know more about technology or specialized software for my area of study.	1	1	7	58	200
15.- ICT's are a means to foster personal relationships with my classmates.	6	31	64	127	39
16.- I like to use a computer for my daily activities.	5	26	54	120	62
17.- I use ICT's in my daily activities	4	24	73	126	40
18.- ICT's favorably change our daily lives.	1	14	57	115	80

Table 2. Items related to the perception of ICT in academic and daily life. Source: personal (2013)

In relation to the perception of ICT in classes, most state that they can be fulfilling, innovative and dynamic thanks to the opportunities

that technological tools provide, and that they are a complementary element to their training outside of class. This can be seen in Table 3:

Item	Strongly Disagree	Disagree	Unsure	Agree	Strongly Agree
19.- Classes can be enriched by the opportunities provided by ICT's.	0	6	34	133	94
20.- Classes with ICT's are innovative and dynamic.	1	14	41	131	80
21.- ICT's are a complimentary element for my learning outside the classroom.	2	6	32	154	73

Table 3. Items corresponding to the perception of ICT's in classroom activities. Source: personal (2013)

Regarding institutional technological infrastructure, students state that they do not know if the computer laboratories of the Engineering School have specialized engineering software, as presented in Table 4.

Item	Strongly Disagree	Disagree	Unsure	Agree	Strongly Agree
22.- The computer laboratories have specialized programs in Civil Engineering.	28	47	99	69	24

Table 4. Items related to the perception of the academic technological infrastructure. Source: own (2013)

Finally, the perception of the use of ICT by teachers indicates that most students think that they like that their teachers use ICT in class, that they are a means to communicate with them outside of class, and they can be a complement to the explanations of teachers and believe that further study in the use of ICT should be done in the area. However, students are not sure if the teachers are trained in the use of ICT and if they like to use ICT in their classes. Table 5 presents the items corresponding to this paragraph.

Item	Strongly Disagree	Disagree	Unsure	Agree	Strongly Agree
23.- ICT's are a medium that allow me to communicate with my professors outside of class	19	41	83	100	24
24.- I like that my professors use ICT in class.	4	11	47	156	49
25.- My professors are trained in the use of ICT.	9	28	118	89	23
26.- My professors encourage academic activities using ICT.	9	47	90	99	22
27.- My teachers like to use ICT in their classrooms.	15	47	125	73	7
28.- I believe that ICT can be a complement to the explanations of my teachers.	3	12	37	162	53
29.- I consider that my teachers need to provide further study in the use of ICT in my area.	4	8	39	135	4

Table 5. Items related to the perception of teachers using ICT Source: own (2013)

Conclusions

Overall, results indicate that the attitudes of the students are accepted as in favor of the use of ICT, both in their academic activities and in their daily lives. However, perceptions that they have of their teachers in the use of ICT in lessons is uncertain. Students do not know if their teachers are trained in using these technological tools, if they like to use ICT in their classes, and do not know if their professors encourage academic activities using these technologies.

According to the results of the items related to block which refers to the perception of students about their teachers and ICT, there is a very limited use of technology by university professors of the Engineering School in their teaching practice. Teachers are not taking advantage of the favorable attitude manifested by the students for the integration of these technologies in their educational context, ignoring the expectations of their students to use them.

Another trend that indicates a limited use of ICT in the Engineering program is the lack of students awareness that specific engineering software is available in the computer labs.

In regards to the statistical results, we can say that TCT scales meet an acceptable internal consistency, since in both scales the alpha was

above .80. In other words, from the TCT statistically based empirical evidence was found that students' attitudes towards the use of ICT are favorable and improve the quality of the learning process.

As stated above, it is important to reflect and develop studies on the actual use of ICT by teachers in their academic activities since the UNACH has participated in projects supported by the Federal Government , which has resulted in the establishment of a solid technological infrastructure (Garzón , 2009). There is also a favorable attitude on the part of students to integrate technology into their learning.

References

Arnal , J. , **Del Rincón** , D., and **Latorre** , A. (1992). *Educational research . Fundamentals and methodology*. Barcelona : Labor .

Colas , M. & **Buendia** , L. (1998). *Educational Research*. Sevilla : Ediciones Alfar .

Garzon , R. (2009). *Model digital literacy for academics from an empirical study of the Autonomous University of Chiapas , Mexico* . Doctoral Thesis in Education.

Faculty of Education at the University of Salamanca . Salamanca , Spain . 2009.

Ledesma , R. , **Montes** , S. & **Poó** , F. (2010). *Psychometric properties of the social desirability scale Driver* (Spanish version) . *Psychological avaliação* [Journal], 9 (2) , 299-310 .

Retrieved <http://pepsic.bvsalud.org/pdf/avp/v9n2/v9n2a14.pdf>

Marcano , M. , **Marcano** , N. & **Araujo** , D. (2010). *Attitude of students in colleges address the Information Technology and Communication* . *Telematique* [Journal], 1 (6) , 77-106 . Retrieved <http://redalyc.uaemex.mx/src/inicio/ArtPdfRed.jsp?iCve=78460105>

Martinez , R. (2005). *Psychometrics : Theory of psychological and educational tests* . Spain : Polity Press .

Messick , S. (1989). *Meaning and values in test validation: The science and ethics of assessment* . *Educational Researcher* , vol . 18 , # 2 , 5-11 .

Morales , P. (2000). *Measuring attitudes in psychology and education*. Madrid : Universidad Pontificia Comillas.

Moscovici , S. (1988). *Social Psychology* . Spain : Polity Press .

Munné , F. (1986). *Social Psychology* . Spain : CEAC.

Muñiz , J. (2003). *Classical Theory of TESTS* . Madrid : Psychology Pyramid .

Ospina , B. , **Sandoval** , J. , **Aristizabal** , C. & **Ramirez** , M. (2003). *The Likert scale in the assessment of knowledge and attitudes of nurses in health care* . *Research and Nursing Education* [Journal] , 1 (23) , 14-29 .

Retrieved <http://redalyc.uaemex.mx/redalyc/pdf/1052/105215401002.pdf>

Ruiz , C. (2011) . *Validity* . Retrieved June 20, 2012 in <http://investigacion.upeu.edu.pe/images/7/74/Validez.pdf>

Sampieri , R. , **Collado** , C. , **Baptista** , P. (2006). *Research Methodology* . Mexico : McGraw Hill .

Studying Medicine: between Fantasy and Reality

Laura Elena Trujillo Olivera
Sofia Isabel Villafane Trujillo
Nestor Rodolfo Garcia Chong
Octavio Orantes Ruiz

About the authors

Laura Elena Trujillo Olivera
Sofia Isabel Villafane Trujillo
Nestor Rodolfo Garcia Chong
Octavio Orantes Tuiz
Full time professor at the School of Human Medicine,
UNACH. Health Promotion and Education Academy. Email: ele-
na2_333@hotmail.com ltrujillo@ecosur.mx

Sofia Isabel Villafane Trujillo
Psychologist, Veracruz University

Abstract

Qualitative educational research was done during a curriculum redesign exercise for the undergraduate program in Human Medicine during 2010-2011. The purpose of this study was to identify the professional life plans and motivation of students in order to guide medical training at the UNACH, as the base for medical education. The data was collected with different methodologies, and were considered as factors to consider during the curriculum redesign.

There were 154 participants from first and tenth semesters (2 and 4 groups, respectively). Participants responded to an inquiry which included three questions referring to their age, gender and course load. The information that was collected was categorized according to content analysis.

The motivations shared by the students, indistinct of their gender, focused on the vocation of service and their interest in the human body with the intention of relieving pain and suffering caused by disease. Most students intended to continue to study a specialization and sought to acquire social prestige in the medical field. However, the individual's perspective focused on almost exclusively financial success, omitting humanistic motivation to relieve disease. Therefore, professional development has been measured in those terms.

The discussion focuses on the nuances of such future expectations of the students given the context.

Keywords: medical education, curricular design, Chiapas, educational research.

Introduction

Evaluations of different classes and origins associated with medical education are closed instruments. The closed instruments (scales, multiple choice, dual answers) of perception and opinion, among other aspects that evaluate medical education, imply that those who evaluate know the behavior of the variables with sufficient depth in order to determine the possible answers that would be obtained during their application. There is nothing further from the truth when, in

this case, you are dealing with projects of professional life of the Medical students at the Autonomous University of Chiapas.

The curriculum from 1993 had its epistemological origin centered on community medicine, with a preeminent humanistic focus oriented on the social function even in the face of recognizing the scientific and technological advances of genome medicine. Nevertheless, in the hidden curriculum, there was not only a devaluation of community medicine but a favoring of a utilitarian vision of the medical profession among students. The current curriculum of the undergraduate medical program at the Autonomous University of Chiapas consists of ten semesters, one year of Rotating Undergraduate Internship and an additional year of Social Service, which is mandatory by law.

The fact the students are self-taught, and the role of the academic personnel at the Medical School is blurred regarding ethical aspects, configures a contextual framework that offers a greater complexity in the training of the doctor in this public university located in southeastern Mexico.

Living in the first decade of the 21st century, we bear witness to intense modifications of social arrangements. The market economy, according to Mendez (2010), is oriented towards the search of the satisfaction of individual needs in detriment to the public needs. This is expressed as individualism, among other characteristics of human behavior.

This phenomenon is congruent with the focus on globalism of Granda (2006) which in a critical manner identifies that social changes should not be considered an irrevocable fate and that rationality and efficiency of wild capitalism should not dominate humanism, attending to indifference without intervention.

Humanism is one of the privileged features in the field of medicine, according to the 1993 Curriculum for the undergraduate program in medicine from the Autonomous University of Chiapas.

A comprehensive revision of the curriculum is an elemental pedagogical principal, particularly in higher education programs focused on medical education.

In the process of curricular revision, it is relevant to define the goals of medical students with the objective of analyzing the epistemological relevance of medical education.

As far as educational investigation is concerned, the institution takes the role of beneficiary of the project, with a particular benefit to the Committee of Curricular Redesign and the Alumni program.

The purpose of this investigation is to come closer to understanding the professional life project and motivating forces that guide the development of an UNACH doctor.

Methodology

Educational investigation refers to the application of a qualitative methodology. (Buendía y Colás, 1998; 1998a). It is fair to assume that the student's perceptions about their own arguments for studying medicine are different according to their maturity level and several other aspects. The participants were students from first and tenth semesters from the medical program enrolled at the Autonomous University of Chiapas.

The hypothesis was divided in that the recently admitted students had a distinct perception to those who were soon to finish the academic phase of their studies. At the beginning of the school year of 2010 and 2011, an instrument with open questions was applied to two groups from the first semester and four groups in the tenth semester at the Medical School. They were answered anonymously-only identified by age, gender, and semester.

In this manner a sample of 154 participants were considered as a non-probabilistic class and convenient type. In the second school year of 2011, the School had a registration of 1200 students without counting the undergraduate internship rotation and social service.

The instrument consisted of three questions, I) Why are you studying medicine? II) What is your professional development project? And III) How do you see yourself in ten years? The instrument was applied during the first session of the school year, and it was requested that there was no communication between the participants, and that they may express their answers for the length that they desired. It is important to note that these instructions generated numerous different answers, a number greater than the number of participants.

The data that was collected was used to develop analytical categories for each of the three questions. The variables of age and gen-

der were captured in an Excel database, from which central tendencies and dispersion measurements were developed. The technique of content analysis was applied to the three open questions (Hernández, Fernández y Baptista, 2004) in order to achieve an interpretation of the data that was close to the reality described by the students.

Results

154 answer sheets were used for the analysis corresponding to an equal number of participants. Of these, 65% belonged to the youngest group (first semester); a little more than half were men (54%). The composition of the participant sample, according to age, is summarized in figure 1.

Measurements /age	Gender and Group			
	Women		Men	
	First	Tenth	First	Tenth
n=154 (%)	47 (30.5)	24 (15.6)	52 (33.8)	31 (20.1)
Average	19.2	23.7	19.1	24.3
Mean	19	24	19	24
Mode	19	24	19	23
Standard deviation	1.0	1.0	0.8	1.6
Range	6	4	2	7

Figure 1.

The sample was balanced equally according to age, with males representing a slightly higher number (53.9%); nevertheless, there was a majority of young males (1.5:1) in accordance with their school group. Among females, the ratio was two to one, in favor of the youngest.

Why study medicine?

162 answers were obtained for this first question, and four categories were identified for analysis, which were described in order of frequency: the category that obtained the highest frequency of answers is what we called “motivating perception”, which referred to the appreciation that society dotes on the medical field and that motivates students to study medicine in order to acquire the characteristics of those who practice it.

In total this first category more than half of the answers (51.2%), were described in various ways. The most common answer was the “conviction of service, as related to the abnegation of the professional practice.” The second most common argument for studying medicine was for the “interest in the functioning of the human body and the possibility to cure disease”. In other words, the motivation to study medicine is separate from the attributes that society has conscribed to those who practice this profession. (See figure 2.)

Categories		Women	Men
1. Motivating perceptions	Interest in medicine and the human body	24	33
	Conviction to serve	47	25
	Give back to society	0	22
	Noble and humanistic career	11	17
2. Personal and familiar	Conviction and vocation	48	26
	Religious motives	6	1
	Only option, self-imposition	5	1
	Family pressure	4	8
	Integral development	3	12
3. Social perception	Social prestige	0	17
	Influence of mass media	1	0
4. Employment	Economic motivation	4	11
	Have a specialization	0	1
	Stable employment	2	1
5. Undefined	Undefined	0	1

Figure 2.

The second category was organized under the title of “personal and family reasons”. The conviction/vocation to study medicine was mentioned practically three out of four times. This answer was understood as the certainty to possess the abilities and ideal disposition to be a doctor. In other words, the motivation is derived from the personality traits of those responding. It is important to mention that family pressure and religious motives were indicated in the answers.

The third category was called “social prestige”, and was grouped independently of the first situation in that the group referenced to how society has idealized doctors and that for the simple fact of obtaining a degree they would have the attributes that they obviously now lack.

The “work force” is the fourth category. Women placed the possibility of entering into the workforce in last place; there were only four mentions of monetary retribution that the discipline can generate.

Men made similar comments regarding the motivations to study medicine. In this first category-the motivating perception-they placed the interest and curiosity for the functioning of the human body first, as well placing the possibility of service in second place-opposite of what women responded.

The options within this category were classified differently for the individual responses, since the retribution to society referred to the belonging to a particular social group to who they owe the opportunity to be a doctor. The conviction of service referred to the possibility of personal interaction in the curing of a specific disease.

Among men the second category was occupied by the “personal and/or family motives”, where the recognition of abilities is the attribute which favors career choice. It should be noted that between men the presence of family pressure and religious motives was also identified. (See figure 2).

In third place for career selection for men is “social prestige” which is shaped by society. Although in the same position, the frequency that males mention this motive is substantially higher.

It is important to remember that the differences between genders are minimal, in as much as participation in the group as in the nature of the answers.

The fourth option that males indicated referred to those that, apparently, offer the job. They wrote sentences related to income and alluded to economic success in stable employment. It is necessary to note that there were cases in which they did not want to – or maybe were unable to-identify the motives that guided them to choose to study medicine. The situation is complex, since it is possible to speculate that perhaps they were unable to identify or verbalize their personal decisions.

Personal development project

Within the personal development project that the women suggested was the first category in which appears a clear interest regarding being placed in a workforce that allows them to have a stable job, and that they could develop their knowledge and abilities a bit more than hypothetically they would acquire during the course of their training.

Practically four out of five women clearly identified their intention to study a specialization (79%). In this category it is important to note that the expectations, in many cases, were short term. This is proven by the intention to surmount the last two cycles of their studies (internship rotation and social service), which can be considered in this context as a great challenge. (see figure 3)

Categories		Women	Men
1. Employment	Have a specialization	56	52
	Finish a career	34	35
	Service	14	5
	Stable employment	8	9
	Success in social service and internship*	3	0
	Dedicate myself to teaching and investigation	2	5
2. Obtaining status	Social prestige	12	11
	Professional success	10	9
	Economic retribution	2	0
	Open a private clinic	0	4
3. Personal and family	Integral development	7	5
	Religious motivation	2	0
4. Undecided	Have no idea	0	3

* This refers to the following curricular phase, the undergraduate rotating internship and social service

Figure 3.

As a second category, according to frequency, is obtaining status which is indispensable for women during their training- achieving or having achieved all of the characteristics-illusory or not-that a doctor possesses: to be cultured, be loved by others, be respected, have answers to questions that affect people's lives (health, sickness, medical attention), among others. Professional success and economic retribution are also included in this category but to a lesser degree.

In the third and final category we find the reasons of family and personal motives for how to develop a career without leaving aside their personal development, such as their religious motives.

In the second question, in order to express their expectations of professional development, the men stand out with a much greater frequency of mentioning their dedication to study a clinical specialization (52%), similar to what was expressed by the women. In very few cases men mentioned dedicating themselves to serve as a professional development project which contrasts with their answers as to why they chose to study medicine. There were much fewer mentions that they consider the possibility of dedicating themselves to investigation and teaching. (see figure 3)

Many men mentioned that finishing their studies successfully as a professional development project, which is congruent with the fact that there are an important percentage of young men beginning their studies. Nevertheless, they are unable to get some idea that the conclusion of their undergraduate studies is an essential element of their professional development. If they are lacking in their professional development it is impossible to achieve subsequent development. This condition applies to all students.

The third category is obtaining status, where the achievement of social prestige is reiterated as the most important factor for these students. Some only mention their yearning for professional success, which is as subjective as achieving social prestige. Much fewer men, even though the women did not mention it, plan to professionally develop independently in a clinic and/or private practice.

When considering all of the participants, there is agreement that there are a greater number of men with an undefined professional development project. Some responded with much sincerity that they had no idea what they would do to achieve professional development.

How do I see myself in ten years?

The students were asked about their future plans over the next 10 years and what they would be doing during this time, considered medium term. Among women, the first important category according to frequency refers to status and financial success, where the most representative element is to have obtained a stable job with all that

it implies. Within this same category but with a lesser level of importance we found having achieved social prestige, have a private practice or clinic, and a stable successful job. The element that was least frequently mentioned was the economical retribution from their job. (See figure 4).

Categories		Women	Men
1. Status and financial success	Social prestige	6	15
	Stable employment	49	46
	Open a private clinic / office	5	0
	Economic retribution	2	5
	Successful job	3	15
2. Professional development	Have a specialization	33	23
	Conviction to serve	6	0
	Continue studying	4	9
	Be dedicated to teaching and investigation	3	2
	Work in a marginalized community	2	2
	Integral development	3	0
3. Personal and family	Form a family	7	14
	Religious motives	0	1
	Family independence	1	0
4. Undefined	Have no idea	3	0

Figure 4.

As the second category of this investigation alludes to professional development, where having a specialization is the highest priority in this group of female medical students. The remaining elements of this category appear much less frequently, for example the conviction to serve others, continue on to study a masters or doctoral degree, as well as dedication to teaching, achieve an integral development and work in a community of limited resources. These comments are detached from the motivations expressed in the first question.

The third category refers to family and personal motives. In this case, the major priority of this category refers to forming a family. In some cases specifics were given, whether it was the partner or of their children.

Also in this category there was indecisiveness, which is worrisome. It doesn't matter that it is presented in the categories as one of the least important elements, rather that it was present at all- The inability to decide and define what one will do at the end of studies.

After questioning the men about how they visualized themselves in 10 years in the first category that refers to professional de-

velopment, the most important option refers to having a stable job; in second place with half the frequency-having a specialization and working in that field. Other least frequent options refer to continuing their training, understood as studying a masters or doctoral degree, as well as imagining serving others when there is physical malaise or sickness present. The least mentioned element was dedication to teaching and investigation.

The second position in this corresponding category was obtaining status and financial success, understanding this as how to achieve all of their goals and expectations that they proposed, obtain social prestige- although none of the 154 instruments that were answered specified what they referred to by "success", to get a desirable financial retribution and open a clinic or private practice.

The final category referred to family plans where the principal goal was to have a family and to have mixed religious motives. It is assumed that the greater that this topic was mentioned corresponds to the priorities of those who responded to the question.

Discussion

In the participants discourse at least three central ideas are identified: studying medicine for a vocation to service; aspire to become specialists and have economic success, and as a consequence enjoy social prestige. However, a significant number of arguments of a different nature arose, including religion and family pressure. An unknown amount of students are children or family members of physicians.

Although participants clearly expressed that their motivations are specifically humanistic (dedication to service, not wanting to see people suffer disease, among others), responses become contradictory. In the same role they say they want financial success, personal welfare and acquire the prestige associated with the title. There were no significant differences in responses according to neither sex nor age.

From psychoanalysis, father and mother figures have complementary functions that permeate the practice of medicine. This discipline embodies –for those who practice it - both functions, paternal and maternal. In the Western tradition, a physician is recognized

as a person of prestige in a society (phallic symbol), who should be wise (intellectual superiority) and possess deep knowledge of the human body (omniscient). They should attend to the patients (care of the body) and prescribe treatments (regulate behavior); they have the power to invade the vitality of the patient (physical power over the body), by one's own wishes. Additionally, they possess attributes that fulfill the core functions of the mother figure: know how to care for others, give solace in the case of anxiety, suffering, or pain; to provide a sense of security and protection to those who go to them and, finally, demonstrate an image of nobility, selflessness and humanity. The stereotypical image of the physician is a smiling gray-haired man that inspires safety and comfort, always wearing a white coat and a stethoscope around his neck (Jullien , 1990) .

In the questionnaires we found some mentions of deities and religious figures. It is important to remember that the (principal) figures within the Catholic religion (considering that most of the participants are Catholics) are men – which is not coincidental - and in whom are also combined both psychic functions : God, the caregiver, makes one feel good and comfortable as would a person who fulfills the maternal function-at the same time providing protection , care, weapons in the defense of an attacker (physical , psychic or spiritual) , prescribes guidelines of conduct and exercises power , and therefore also plays a paternal role . In the participant's writings, there is a repeated reference to this power – the power of cleaving into a living body, introducing their hands into people, change their bodies (by surgery) and eliminate disease. That power generates the perception of superiority (Foucault, 1963 , 1979) and omnipotence.

From this perspective some statements of the participants can be interpreted, who “ do not want to be like God “ but rather “ want to be instruments in his hands,” do not conceive (or maybe they do but do not admit it) that they want to have equal or greater power than someone who is considered a deity, but want to be “ the next in line” in the hierarchy.

Returning to reality, Mexico is a country with 52 million people living in poverty and Chiapas is one of the entities in the country with the highest levels of social need (CONEVAL , 2011) . This situation strongly affects the probability that the population is financially solvent for regular medical care, without omitting that poverty is a crucial factor for collective health and disease.

Conclusion

Medical students at the UNACH have an overrated perception of medical prestige, created by fictional characters that abound on television. They claim to have altruistic and humanistic motives but favor the satisfaction of their own needs through the practice of medicine. We believe that they are in their legitimate right to pursue a career and earn an honest income. What we disagree is that students justify and validate their motivations under altruistic arguments, which is absent in the majority of the cases.

The ideas of superiority associated with traditional stereotypes of a doctor are blurred in reality due to in part to overcrowding in medical schools, and in part for the tendency to skip the pre-eminent principle of doing good- placing the profit motive over the welfare of the patient. Therein lays the fantasy, because presently in Latin America we are witnessing a transition arising from the reforms in health systems. Among the side effects is found a radical change to the arrangements of the professional working relationship with the National Health System (Infante , de la Mata and Lopez , 2000) .

In this framework of reforms, the precarious situation of large sectors of the Latin American population is included, which has been omitted from the assessment that the World Health Organization and its regional office , OPS , has elaborated (Torres , 2007) . The author maintains the position that training of personnel has been neglected in the majority of the countries that were evaluated. To date, the national policy on medical education is geared towards skills. At the Autonomous University of Chiapas we opt for integrated comprehensive skills as the pedagogical foundation for curriculum redesign.

Considering some other elements to recognize the reality, Correa (2006) among others, argues that the social crisis and in particular ethical and bioethical values are linked to the loss of the sense of authority figures that some doctors embody- the doctor among them , the father figure. This perception is congruent with the empirical observation of increased lawsuits presented by health service users or their families because of dissatisfaction with their care or undesirable results derived from the doctor : iatrogenic or death .

Practicing a profession and enjoying the privileges that this creates is considered legitimate, however , is it questionable to have a degree that requires an investment of effort and resources for just over seven years to then reach a stark and difficult reality of unemploy-

ment and / or underemployment , even among specialists . However, it would never be pointless to reiterate that medicine is a profession that plays an important social role for the welfare and lives of people in every society. Humanism and ethics are attributes that should be required in order to study medicine.

It is under these considerations, coupled with current educational policy, that the curriculum redesign gives a new direction to its Study Plan III in the Bachelor's program in Human Medicine.

References

- Eisman** Buendia and **Pilar** Colas Leonor Bravo . (1998). *Educational Research*. Madrid : Alfar .
- Eisman** Buendia and **Pilar** Colas Leonor Bravo . (1998a). *Research Methodology Psychology* . Madrid : Mc Graw Hill .
- National Council for Evaluation of Social Development Policy , CONEVAL . (2011) . Poverty in Mexico and federal entities , 2008-2010 . Available at: www.coneval.gob.mx . Accessed February 2012.
- Correa** Gonzalez, Eleazar . (2006). " The decline of the power of the father " Magazine " Furies " . Journal of Applied Psychology , Psychoanalysis and culture. Edited by the Free School of Psychology . Puebla. Year II , Number 5 Spring 2006.
- College of Human Medicine / UNACH . Curriculum 1993 . (1994). Document internal circulation .
- Foucault** , Michael . (1966). *The birth of the clinic*. Buenos Aires : Siglo XXI Editores Argentina . 304 pp .
- Foucault** , Michael . (1979). *Power - Body . Microphysics of power* . Madrid : Edissa . 103-110
- Granda** , Edmund. (2006). "Globalization of health risks " , *Nal Fac Rev Public Health*. 24: 111-128
- Roberto** Hernandez , **Carlos** Fernandez and **Baptista** Pilar . (2003). *Research Methodology* . Mexico : Mc Graw Hill .
- Alberto** Infante , **De la Mata** Elizabeth and **Daniel** López- Acuña . (2000). "Reforming health systems in Latin America and the Caribbean: situation and trends " *Pan Am J Public Health* 8 (1/2) , 2000
- Jullien** , Phillippe . (1990). *Supremacy of the phallus* . The parental role : Seminar from 27 to 30 July 1990 . Available at: Retrieved April 15, 2012 .
- Torres** Tovar , Mauritius. (2007). *The challenge of developing public health as opposed to private healthcare* . *Journal of Public Health*, 33 .
- Menendez** , Eduardo. (2010). " Participation in health as technical reality and as an imaginary social private practice". *Medical Papers* 73 (5-22) . Available at: http://www.ilazarte.com.ar/cuadernos/2010/07/participacion_social_en_salud.html Accessed September 2011.

Characterization of the subsystem of medicinal plants in the patyotyoty (backyards) in the community of Amado Nervo , Municipality of Yajalón , Chiapas, Mexico.

Rosa M. Aguirre Ruiz
Nelvi G. Torres Vázquez
Elvira P. Vázquez Trujillo
Olga L. Jiménez Guzmán
Ana S. Ruiz Sánchez,
Jorge Antonio Velázquez Avendaño

About the authors

Rosa M. Aguirre-Ruiz
Nelvi G. Torres-Vázquez
Elvira P. Vázquez-Trujillo
Olga L. Jiménez -Guzmán
Ana S. Ruiz Sánchez

Students from the IV semester of the B.A. program in Sustainable Development at the Multidisciplinary Academic Unit in Yajalon, Intercultural University of Chiapas 2013

Dr. Jorge Antonio Velázquez - Avendaño
Professor-Investigator of the Multidisciplinary Academic Unit in Yajalon, Intercultural University of Chiapas.
Contact: javelazqueza@gmail.com

Abstract

A study was conducted with the purpose of making a characterization of backyards (*patyotyoty* in the Chol language) in the community of Amado Nervo, located in the municipality of Yajalon, Chiapas, which contemplated an inventory of medicinal plants, their use and management. The study offers a general description of the natural resources of the *patyotyoty*. The medicinal plants were described in greater detail. Information was gathered using a semi-structured interviewing technique, direct observation and a field log. The size of the sample was calculated by simple random sampling (Zar, 1999) in 39 backyards. The results indicated that in the community of Amado Nervo there are 1391 inhabitants and 277 families, including seven midwives who are registered with the IMSS clinic. The inventory indicates that the plants are for use by the families, and there is no commercialization. The most common plants are: basil, wormwood, garlic, marigold, *chanita*, peppermint, fennel, purple maguey, *chaya*, licorice, Mexican wormwood, *yaxbak*, oregano, pennyroyal, rue, lemongrass, aloe and parsley. It was found that in 26% of the *patyotyoty* there were no medicinal plants, and in 61% organic fertilizer was applied for the plants cultivation. It was concluded that the use of homeopathic medicines such as medicinal plants are used frequently to treat ailments and that 39% of the inhabitants used them as an alternative due to the lack of economic resources.

Keywords: Backyard, medicinal plants, Chiapas

Introduction

The purpose of this study is to identify the characteristics of the backyards in the community of Amado Nervo, located in the municipality of Yajalón, Chiapas, - an agro ecosystem with plant and animal production characteristics. The study focuses on the management and use of medicinal plants.

Medicinal plants are a natural resource of great importance which are cultivated in backyards and are used to maintain health in communities. The same backyards also provide from 25% to 75 % of food in Latin America (FAO , 2011) . In this context, the primary focus

of the study was the registration and identification of the diversity of medicinal plants which are known to be preserved in backyards, but are not recorded nor have been identified in detail. Consequently, this study is warranted in light of the aforementioned assumptions. For the purposes of this study, every medicinal plant was identified and recorded together with a description of its use and its role.

Methodology

1. Location of the study area

The community of Amado Nervo is located 25 kilometers from the county seat of Yajalón, Chiapas, $17^{\circ} 13'45.28''$ N latitude and $92^{\circ} 14' 43.30''$ west longitude with respect to the Greenwich meridian.

The town has approximately 1,177 inhabitants according to data from INEGI (*Instituto Nacional de Estadística y Geografía, National Institute of Statistics and Geography*) (2011), who speak the Chol language.

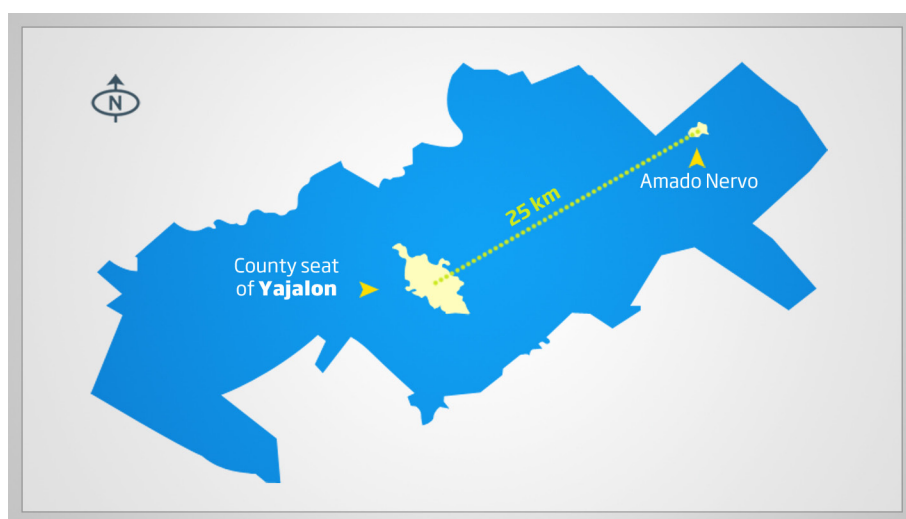

Figure 1. Location of the study area, Amado Nervo, with respect to the county seat of Yajalón.

2. Delimitation of the sample

This study applied 39 interviews aimed at midwives in Amado Nervo, 16 randomly selected people who are not midwives but have back-

yards and grow medicinal plants , and an interview with the family doctor and nurse at the community's IMSS rural clinic.

3. Site visits for data collection

Site visits were performed at randomly selected backyards of the possible 277 that exist in the community (Figure 1). These visits permitted an assessment of the amount and diversity of medicinal plants found at the selected sites.



Figure 2. Panoramic view of the community of Amado Nervo, Municipality of Yajalon, Chiapas.

4. Inventory of the productive subsystem of medicinal plants.

During the site visits, those responsible for the *patyotyoty* were contacted to make a record of the medicinal plants and their uses. At the same time the sites soil management was registered, as well as the social, cultural and environmental value they assigned to their medicinal plants.

The study was conducted with semi - structured and structured interviews composed of open and closed questions related to the practices that are used with their medicinal plants. The interviews contained the following sections:

- a) General information on the backyard (location, owner profile, shape and size)

- b) Technical and economic information (planting , soil type , types of plants , use, available infrastructure, commercialization aspects)
- c) Structural and socioeconomic (ethnicity, producer organization, union practices) aspects.

5. Data Analysis

The systematization was conducted through an array of a concentration of the data that were collected, considering the following variables: land type, shape and size; main productive activities done for the care of the medicinal plants and soil; Identification of medicinal plants, their uses, and homeopathic medicine developed from them; identification of other plants and animals that compose the backyard; and finally, commercialization aspects.

In order to analyze the variables that were studied, a data matrix concentration was used which was followed by forming groups. The average, median and range of each variable were obtained.

Results and Discussion

The results of the interviews and observations show that the inhabitants of Amado Nervo define backyards in the Chol language as *"patyotyoty"*, which means "behind the house" while there are variations found in other States of the Mexican Republic. For example, in Oaxaca they are called *"traspatio"*(backyards); in San Cristobal de las Casas *"sitios"*(sites) ; in Tabasco *"patio"*; in the Yucatan *"solar"*; in Tlaxcala and Puebla it is called the "family garden" and in part of Michoacán they call it an orchard. They also have an assigned name in the original languages of Chiapas. For example, for Tsotsiles is it called *"patna"* , in Tzeltal it is *patna* or *amak'* , in Chol it is *chili 'b*, and for the Zoques of Pichucalco it is *"angojmo"* according to the variants that exist in each community (Chi Quej , 2009) .



Figure 3. Organization of the *patyotyoty* with diverse medicinal plants and other vegetables in the community of Amado Nervo, municipality of Yajalon, Chiapas.

The *patyotyoty* in Amado Nervo are defined areas located behind the house with subsystems based on vegetables, fruits, medicinal plants and useful animals, as a way to save money and for consumption by the household as mentioned by the FAO(2011).

According to the information documented in this community, 90% of the backyards are rectangular in shape, but not all of the identified subsystems have the same location adjacent to the houses within the plot of land (Figure 2). According to Gliessmann and Somarriba (1981), home gardens have two notable characteristics: the shape and function, with shape referred to in terms of the vertical structure. It is observed that the *patyotyoty* is a shaded space, which determines the management and certain combinations that characterize its use. It also depends on the season of the year which determines plant and animal diversity (Barrantes, 1989).

Within the inventory which was made in the *patyotyoty*, the most common medicinal plants were: basil, wormwood, garlic, marigold, chanita, peppermint, fennel, oyster plant, tree spinach, licorice, Mexican wormwood, yäxbak, oregano, pennyroyal, rue, lemongrass, aloe and parsley (Table 1). Among those who most frequently used these plants were midwives (Picture 3). Chamomile is used for "baby bulge", fennel to counteract post-partum pain, and basil to stimulate the mother's appetite. An interesting fact for its symbolism is the use of incense to avoid the so-called evil eye of the baby, which agrees with what is said by Toledo (2003) about the importance of using other plants or their products for the delivery of a new human being in indigenous communities.

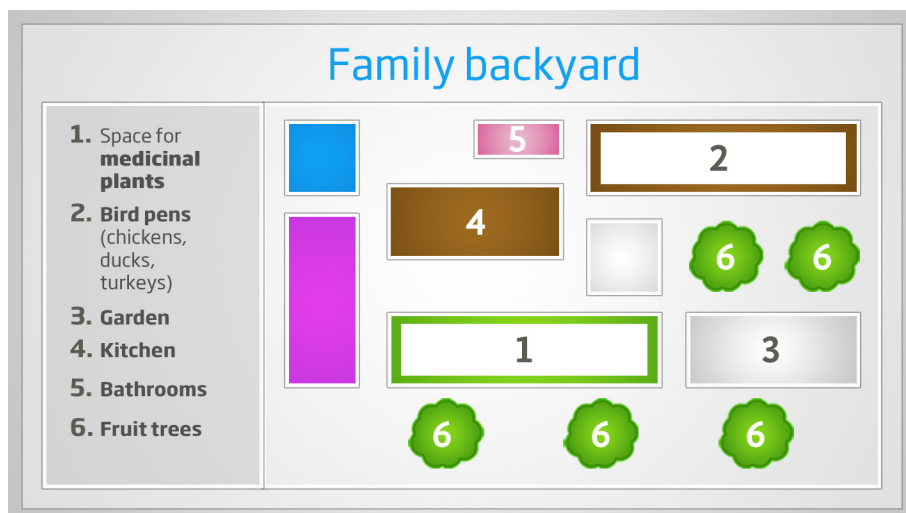

Figure 4. Family backyard area



Figure 5. An interview with Dona Anita, midwife from the community.

The economic importance of patyotyoty is highlighted by the production of fruit, vegetables, herbs, seasonings and meat. Some fruit trees that were identified are orange, lime, banana, mandarin orange; Vegetables such as chayote, silica, and yams; and animals like chickens, pigs, turkeys and ducks which represent an additional contribution to the household economy. According to the FAO (2011), between 25 to 75% of food consumed in Latin America comes from these agroecosystems.

Common name	scientific name	Uses
Basil	Ocimum bacilicum	to cure "fear/being spooked" (espanto) and headache. Midwives use it to stimulate the appetite
Wormwood	Artemisa absinthium	Stomachache
Garlic	Allium sativum	to cure toothache, uric acid, and anti-parasitic
Marigold	Tagetes erecta	for headache, gastritis, conjunctivitis
Chanita	No tiene	for cough
Peppermint	Mentha sativa	for vomiting
Fennel	Foeniculum vulgare miller	for headache, ears and eyes. Pain after giving birth
Oyster plant	Tradescantia spathacea	kidney pain, stomachache, and cough
Tree spinach	Cnidioscolus chayamansa	menstrual cramps
Licorice	Glycyrrhiza glabra	cough
Mexican wormwood	Artemisia mexicana	muscle pain
Yaxbak	No tiene	bone pain
Oregano	Origanum vulgare	ear pain and anti-parasitic
Pennyroyal	Mentha pulegium	babies with fever, "evil eye"
Rue	Ruta chalapensis	fever and stomachache
Lemongrass	Cymbopogon citratus	cough
Aloe	Aloe vera	indigestion, and to heal scars
Epazote	Chenopodium abrosioides	stomach pain and anti-parasitic
Parsley root	Petroselinum crispum	to ease childbirth

Table 1. The most common medicinal plants found in patyotyoty in Amado Nervo, Municipality of Yajalon, Chiapas

The economic importance of *patyotyoty* is highlighted by the production of fruit, vegetables, herbs, seasonings and meat. Some fruit trees that were identified are orange, lime, banana, mandarin orange; Vegetables such as chayote, silica, and yams; and animals

like chickens , pigs, turkeys and ducks which represent an additional contribution to the household economy . According to the FAO (2011) between 25 to 75 % of food consumed in Latin America comes from these agroecosystems .

According to Lok (1988) regarding nutrition, community gardens contribute between 15 % and 30 % of the vitamins and proteins and 40% of calories of the household. It is therefore considered that home gardens represent a kind of insurance, so that the rise and fall of prices of various commodities does not affect the family.

Medicinal plants are defined as plants that produce substances that exert a pharmacological action beneficial or detrimental to the living organism.

According to Traverse et al. (2005) , medicinal plants have certain benefits for their use as medication, they are inexpensive and non-toxic , they are used as seasoning in cooking and in cosmological treatments, and are easy to obtain in the home gardens.

This study found that the main uses of the medicinal plants are for cough , stomach ache, headache, muscle aches, "fear" , colds and as an anti-parasitic treatment. . The most effective method of preparation is to boil them in water and prepare combinations with other types of plants. Another method is that part of the plants, such as its leaves or root, are roasted or crushed which releases their healing properties.

Figure 6 shows that the most common medicinal plants in the backyards are basil and rue (35%) while *chanita* , *epazote* , *momo*, parsley , licorice and *k'umaty'e* are the least common.

These data agree with those indicated by the Community Development Centre of Chiapas (2008), which states that the most common wild and cultivated medicinal plants in backyards in Chiapas are: basil, thyme, rosemary, pennyroyal , oregano, aloe, dandelion , parsley and garlic.

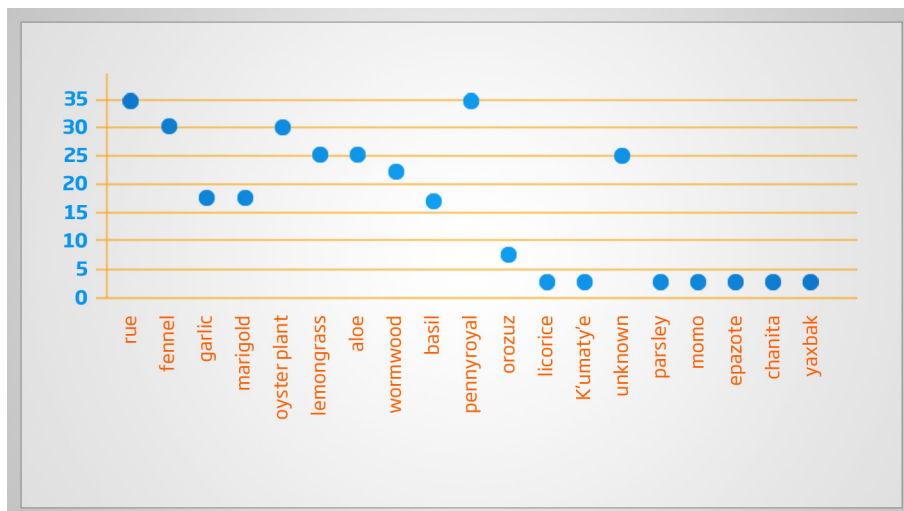

Figure 6. The most common plants in the backyards of Amado Nervo.



Figure 7. Aloe and Rue. Medicinal plants commonly used in the community of Amado Nervo, municipality of Yajalon, Chiapas.

It was found that 61% of the land in the *patyotyoty* used for cultivating plants is “*tierra negra*” (black earth), due to the use of organic fertilizer such as: coffee husks, animal droppings and fruit rinds. 13% are black and yellow earth. There is a type of red dirt used to make various clay objects. It was also found that 26 % do not cultivate medicinal plants (Figure 2) . According to data from INEGI, the predominant soil type in Yajalón Chiapas are Luvisols and Rendizine which are predominant in humid regions with slopes and valleys of cold and warm climates that produces clay , with a large part of the organic material located above limestone rocks.

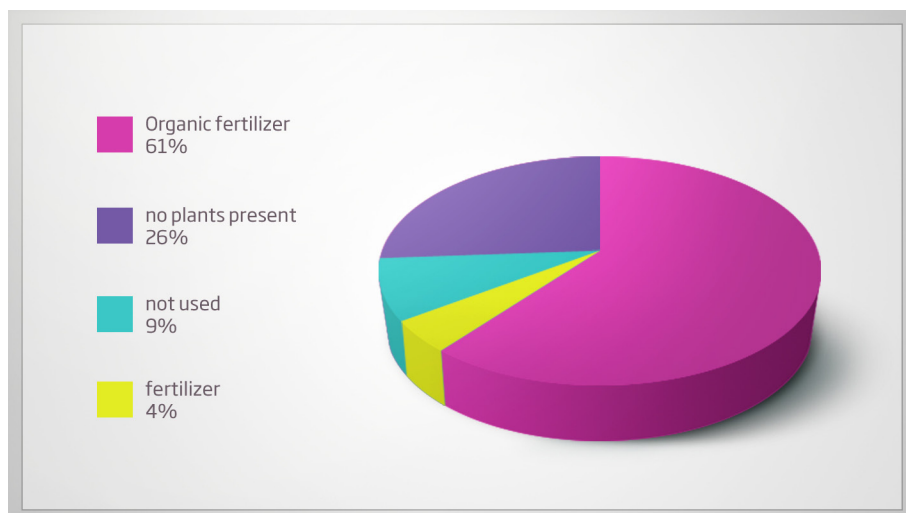

Figure 8. The use of organic fertilizer and chemical fertilizer in the community of Amado Nervo.

The results which were observed indicate that 39 % of people use medicinal plants and at the same time use allopathic medicines that help the healing process, while 35 % only use medicinal plants and 26% only allopathic medicines. The most cited reason for not using allopathic medicines is the scarcity of economic resources (Figure 9).

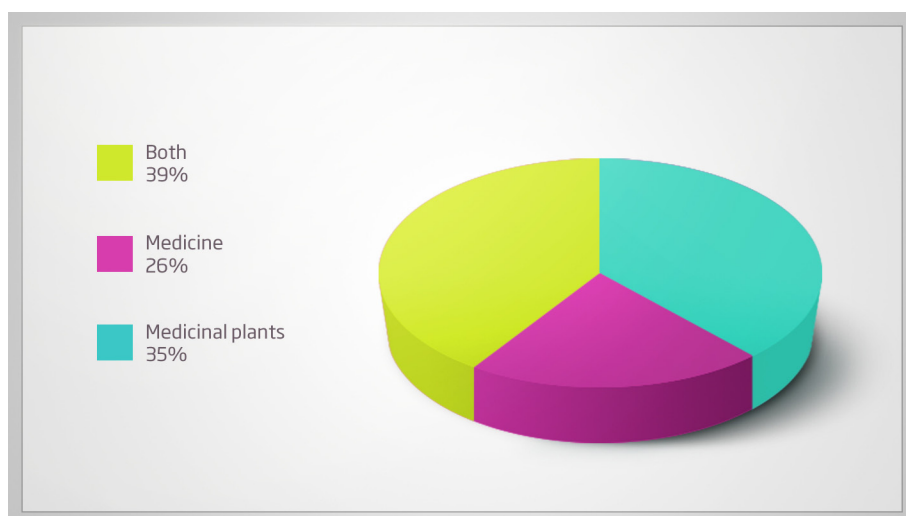

Figure 9. The use of allopathic medicine and medicinal plants by the population of Amado Nervo.

With respect to the care and planting of medicinal plants, it can be observed in Figure 10 that 48% of women are the ones most involved in the cultivation of medicinal plants, from which they obtain what they need for their own consumption or commercialization. 26% mentioned they do not have the plants but somehow use them. 9% are men, and both men and women contribute to the care and cultivation of the plants. 4% are planted by daughters, and 4% did not cultivate the plants as they grow from the seeds of established plants.

The study found that 90% are guided through astronomical indicators for their crops, planting during a full moon (*Chameluj*) which is part of the culture and which has as its secret that they plants will not grow too tall and will have good fruit. During the slash and burn period, 61% of people do not burn their fields. They use all of the organic waste as fertilizer in place of chemical fertilizers.

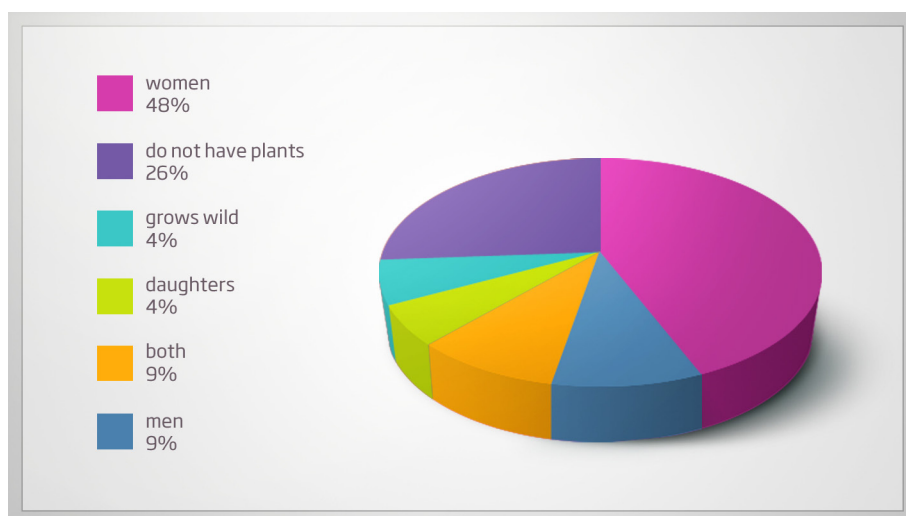

Figure 10. Family involvement in the planting and care of medicinal plants.

It was identified in this community that of the people who are cultivating medicinal plants, 56% do not sell these products as they are for self-consumption while 9% tend to sell the plants if it necessary (Figure 11).

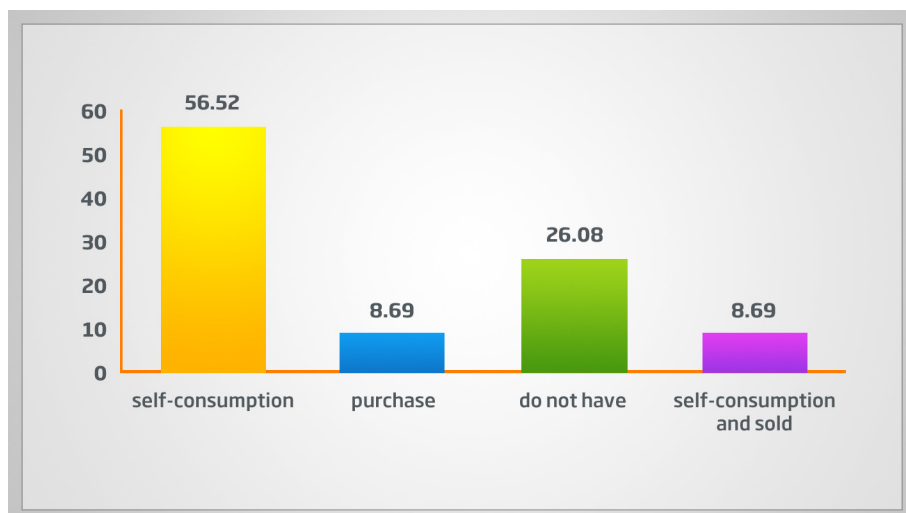

Figure 11. Destination of products of medicinal plants .

26 % do not have medicinal plants but somehow have other types of plants. 9% purchase the medicinal plants somewhere other than Yajalón (Figure 11).



Figure 12. . Purple maguey (oysterplant) and lemongrass, important medicinal plants for families in the community of Amado Nervo.

Conclusions

Cho'l is the language spoken in the community of Amado Nervo. For the inhabitants, the *patyotyoty* is the place where productive economic activities are performed which include various subsystems such as vegetables, animals and the human families that dynamically interact with this space that provides support for sustaining the family economically as well as its integration.

The people of Amado Nervo practice important activities that benefit the environment and themselves, such as the use of natural fertilizers such as decomposed leaves, coffee husks, and poultry excrement which helps maintain fertility and good soil condition and does not damage the soil or plants. They do not burn their cornfields since all corn byproducts are used as compost instead of chemical fertilizers.

The uses of medicinal plants as well as allopathic medicines are of great importance in the community of Amado Nervo, where 36 % use both drugs for rapid improvement of the body when sickness is present. However, the lack of financial resources limits this complementary recovery as many families do not have enough money to buy them. The sale of these plants is negligible, because most people have them in their backyards, which they have for their own use.

References

Chi Quej , Jesus (2009) . *Characterization and management of family home gardens in three ethnic groups (peninsular Maya , Chol and Mestizos)* Campeche State . Mexico . Tropical Agronomic Research Center and graduate school education ,Turrialba , Costa Rica .

Barrantes , U. (1989) *Guidelines for the establishment of mixed tropical orchards* . Technological Institute of Costa Rica , Cartago , CR 132 p

FAO . (2005) *Integrated Family Orchard* . Series informative . FAO -SAG . 16 p .

Gliessman , S. and **Somarriba** , E. (1981). *Characterization of gardens*. In: Beer , J.W. and Somarriba , E. (editors) . Research of traditional agroforestry techniques . Records of training provided in Tabasco , Campeche and Quintana Roo , Mexico . Technical Bulletin No. 12.pp . 86-91 .

Lok , R. (1998). *The traditional tropical home garden in Central America* . In: Lok , R. (editor) *Homemade Traditional Orchards Central America : features, benefits and importance, from a multidisciplinary approach*. CATIE.Turrialba , Costa Rica . pp.07 -28.

Toledo , V.M. (2003). *Towards a bio -regional conservation in tropical regions of Mexico : biodiversity , sustainability and indigenous peoples* . Meeting: Towards an Assessment of Protected Areas of the Tropics. Veracruz , Mexico . pp .1-16.

Traversa , IP ; **Fierros** , AM , **Gómez** , M. ; **Leyva** , JC and **Hernandez** , R. A. (2000). *Home gardens of Zaachila in Oaxaca , Mexico* . *Agroforestry in the Americas* . 7 (28) :12-15 .

The behavior and thermal comfort of housing in the sustainable rural city of Nuevo Juan Del Grijalva , Chiapas , Mexico.

Gabriel Castañeda Nolasco
Pável Ruiz Torres
José Luis Jiménez Albores

About the authors

Gabriel Castañeda Nolasco
Professor at the Architecture School of the Autonomous University of Chiapas, leader of the COCOVI academy. Architect and Doctor in Environmental Engineering. Boulevard Belisario Dominguez Km 1081, sin numero, Teran. Email: gnolasco2@gmail.com
Raúl Pável Ruiz Torres

Professor at the Architecture School at the Autonomous University of Chiapas. Collaborator of the COCOVI academy. Architect and Doctor in Architecture. Boulevard Belisario Dominguez Km 1081, sin numero, Teran. Email: pavelvg@msn.com

José Luis Jiménez Albores
Professor at the Architecture School at the Autonomous University of Chiapas. Member of the COCOVI academy. Architect with a Masters in Architecture.
Boulevard Belisario Dominguez Km 1081, sin numero, Teran. Email: jljimenez67@hotmail.com

Abstract

This paper presents results on the behavior and thermal comfort in the rural sustainable housing community of Nuevo Juan de Grijalva, located in Chiapas, Mexico, during the month of January. In order to measure thermal behavior, Dry Bulb Temperature Variables and Superficial Interior Temperatures were measured; Thermal comfort was analyzed using the adaptive approach, using a questionnaire designed under regulation ISO 10551. This information allowed for the development of proposals to improve the housing design, principally for the use of passive means oriented towards thermal comfort in future developments.

keywords: Thermal comfort, wet weather, rural housing.

Introduction

This document presents the results of the research project entitled "The components and conditions of housing in sustainable rural cities of Chiapas. Case Study Nuevo Juan del Grijalva" by the Academic Body Components and Determinants of Housing (Cocovi) from the School of Architecture at the Autonomous University of Chiapas (UNACH). This paper seeks to contribute knowledge when considering improvements to the homes in the community.

The city is located in the municipality of Ostuacán, in the northern region of the state of Chiapas. It has a warm humid climate with rains in the summer, and an altitude of 320 m above sea level. The project was proposed for a two year period, as the city filled with people for the study who originated from different locations. The majority of the new population was relocated because their homes suffered damage by the collapse of a mountain, causing irreversible damage to the settlement that was originally called Juan del Grijalva.

Background

As part of the extension activities of the UNACH, through Cocovi, a research line was outlined entitled Technology Transfer for Bioclimatic Housing. A project was developed that included the evaluation of various aspects of the rural town Nuevo Juan del Grijalva, looking at the physical aspects of the housing and the settlement as a whole.

This article only deals with the results of the evaluation of the thermal behavior of housing and the thermal comfort experienced by its inhabitants, with the goal to generate a document that particularly serves to train students in the School of Architecture, and if the case, may result in proposals for the improvement of the new settlement houses.

Due to logistical conditions of the project, field work was carried out during the hottest period for the region, however the results will be compared later during a warmer period from April 15 to May 15.

General Objective

Evaluate the thermal performance of housing in the sustainable rural city of Nuevo Juan de Grijalva, and determine the Neutral Temperature (T_n) and comfort zone of people living in the homes for the month of January using the adaptive approach.

Materials and methods

Location of Nuevo Juan del Grijalva

The sustainable rural city of Nuevo Juan de Grijalva is located in the northern region of the state of Chiapas, $17^{\circ} 25'38''$ North Latitude and $93^{\circ} 22'20''$ west longitude. It is located at an average altitude of 320 m above sea level. The area maintains a warm humid climate with rain throughout the year (Fig. 1). There are currently 410 homes, as well as infrastructure, services and equipment that characterize a city.

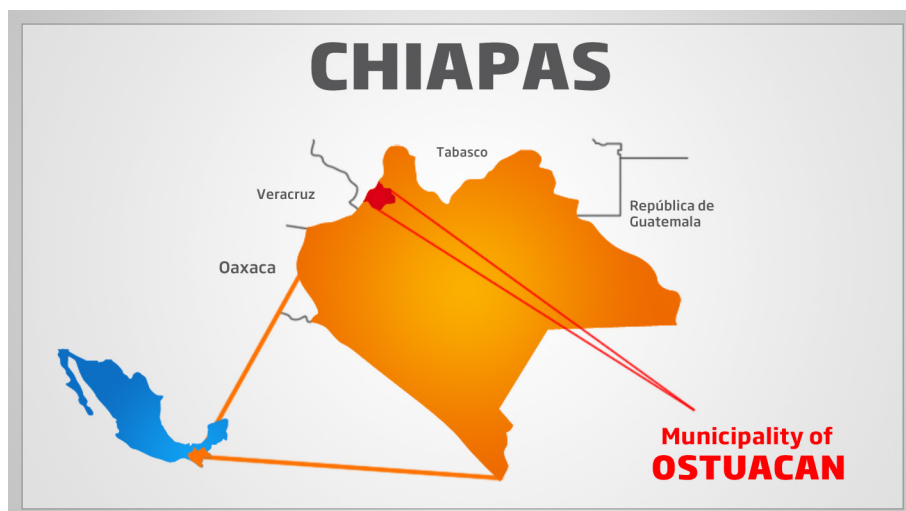

Fig. 1 Location of the municipality of Ostuacan in the State of Chiapas, Mexico. Source: Institute of Population and Rural Cities of the State of Chiapas, 2012.

This settlement was built on the tract of land called “El Cinco”, seven kilometers from the county seat . Fig. 2



Figure 2.

The settlement

The amount of land dedicated for the new town was 80 hectares , 7 kilometers from the county seat of Ostuacán . 50 hectares were used for the urban settlement where 410 homes were built along with facilities and city services. 30 hectares were added that were used for produc-

tive projects such as greenhouses to produce habanero chilies, dairy processing, cocoa processing a packing facility, etc. (fig. 3)

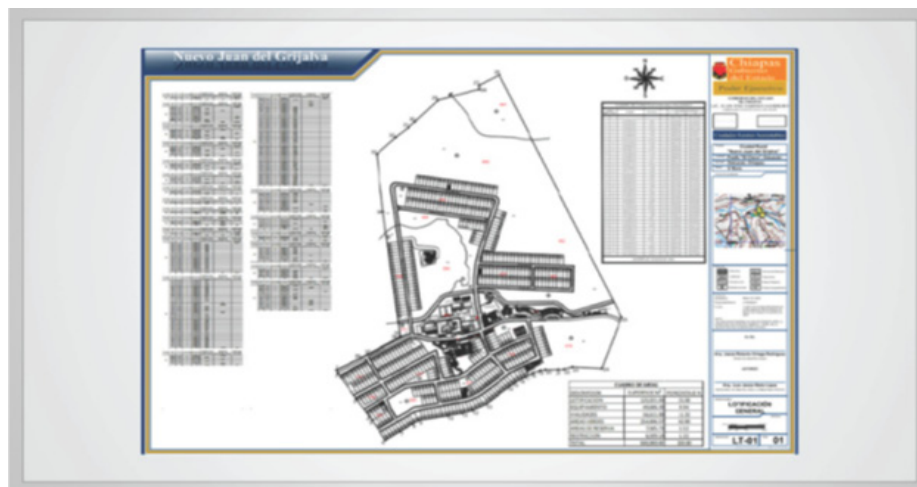

Figure 3. Urban plan for the rural city of Nuevo Juan del Grijalva. Source: Government of the State of Chiapas, 2012

Housing

Permanent housing was built of soil-cement walls with a double layer fibercement roof with a five centimeter expanded polystyrene core for thermal insulation. This design was coupled with the closure of the corridor area, which was insisted upon by as a requirement by the population (Figs. 4, 5 and 6).These changes were considered as final project factors.

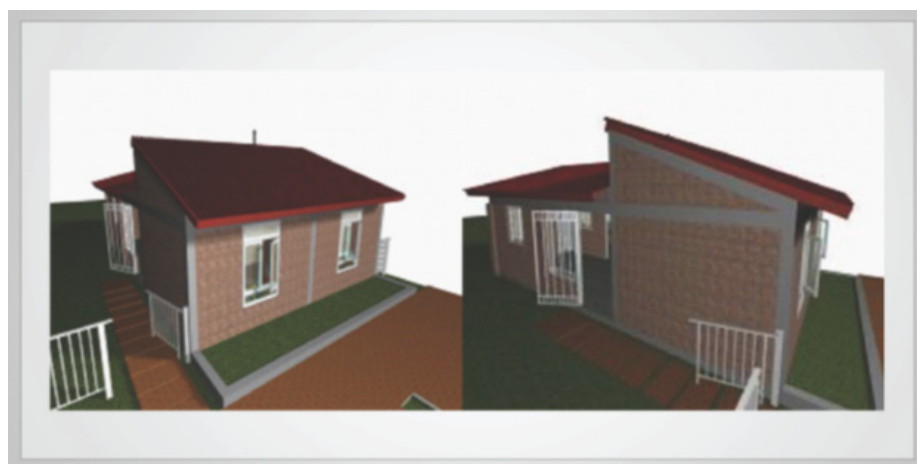

Fig. 4. Housing proposal with a roof of insulated fiber cement sheets and the closed corridor in order to increase the interior of the home. Source: Castaneda Nolasco, 2008.



Fig. 5 Material used in the walls and roof. Blocks of improved (cement) adobe and fiber cement sheets with a 5 cm expanded polystyrene core, with the objective to reduce exterior thermal gain.



Fig. 6. Panoramic view of the Nuevo Juan de Grijalva settlement. Source: Castaneda Nolasco, 2008.

Thermal evaluation

A home was chosen for the evaluation of thermal behavior and HOBO automatic data collection equipment was placed to measure the internal temperature and dry bulb surface temperature. Measurements were taken during 36 continuous hours, taking automatic readings every 20 seconds approximately every half hour.

For the comfort study, households were randomly selected in different parts of the city. 35 people agreed to participate in the study.

The data collection was conducted during the 16 and 17 of January in morning and evening periods. The method for selecting participants who conducted the field work was through direct sampling, since it was a priority to have people who were serious when answering the questionnaires as well as have confidence when deciding where to install the heat stress monitor, which is fragile. Therefore, it was important to choose subjects with certain specific characteristics in a careful and in a controlled manner.

Aspects that were considered for the selection of subjects for the sample

It is important to mention that the characteristics presented are quite synthesized, and are developed according to internal and external factors that influence people's thermal preference.

The aspects considered for selecting people to interview were:

- People aged 11 to 75 years old were surveyed.
- People were living in the city for a minimum of six months prior to the study.
- They are willing to answer the questionnaire.
- Their houses were naturally ventilated.
- That the homes of the selected subjects were located in different parts of the rural city.

Equipment used for monitoring thermal comfort

The data recorded inside the houses were the dry bulb temperature, wet bulb temperature, globe temperature, relative humidity and wind speed. A heat stress monitor QUESTemp 36 was used for indoor monitoring.

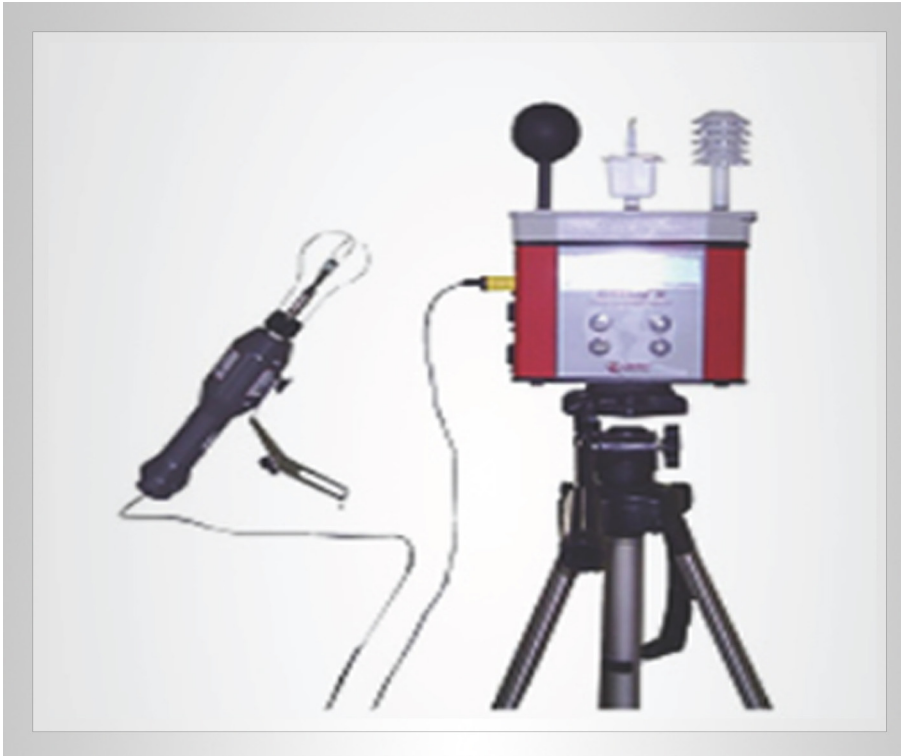

Figure 7: Thermal stress monitor and multidirectional anemometer.

Equipment used for monitoring the thermal behavior

A HOBO DATA LOGGER (ONSET) was used (fig. 8) , measuring the Dry Bulb Temperature (DBT) and Interior Surface Temperature (IST) with an external sensor from the data logger .

The questionnaire was developed from the questionnaire used in the project “Thermal comfort and energy savings in affordable housing in Mexico, warm dry and warm wet climates” (CONAVI , 2005). Other related research was also revised and modifications were made to suit the aims of this study. The questionnaire used was adapted in the doctoral thesis of Pavel Ruiz (2011) . The objective of this survey was to establish the thermal sensation and thermal preference of those occupying the housing.

The survey is divided into 5 parts, which are explained in the following paragraphs :

1) Control data :

Used for recording the dates, the pages of each questionnaire, the monitoring period and the registry of who recorded the survey.

2)General information of the inhabitant :

Filled out in the office, it contains data identifying the inhabitant as well as constants during the monitoring period such as height, weight, and age.

3) Data filled for each answer session:

Temporal data is recorded such as the date and time , and a questionnaire is filled every hour. We want to know the date and time for each response in order to be able to compare the data recorded by the equipment.



Figure 8. HOB0 data logger

Factors that change are registered over time such as the type of clothing worn and climate control devices activated on site, the time spent being in the house and the activity done before answering the questionnaire.

The type of clothing was classified according to the style of dress used at home in the town. For this classification factor we were helped by the "Clo" factor (Innova, 1997) for further later analysis. The activity prior to filling the questionnaire was based on the ISO 8996 (1989). This guideline is part of a series of international standards that refer to the thermal environment. It describes the different methods for determining energy consumption, indicating a level of accuracy for each method.

4) Perception of hygrothermal environment inside the home :

This contains data for the identification of sensation: the preference and tolerance of people living in the household regarding the hygrothermal environment. The thermal sensation, sense of humidity, ventilation, radiation, temperature preference, preference of humidity, ventilation preference, radiation preference and personal tolerance to the thermal environment are asked. The sensation and preference range are taken according to ISO 10551 (Standard which marks the elements needed to make an assessment of the thermal environment based on subjective questions)

5) Physical monitoring data :

This is filled in the office and records the data registered by the heat stress monitor. There are two columns, one for data recorded indoors and another for outdoor data. The recorded data that are measured indoors are the dry bulb temperature, wet bulb temperature, globe temperature, relative humidity and wind speed. The data recorded outdoors are dry bulb temperature, relative humidity and dew point.

Below you can see some photos of data being collected in the homes (see Figures 9 and 10).

Analysis method

For data analysis we used Excel. With this software neutral comfort temperature was found taken from a least square regression. In order

to obtain the thermal comfort zone ± 2.5 was added to define the limits of the area.



Figure 9 & 190

Results of the analysis of thermal comfort

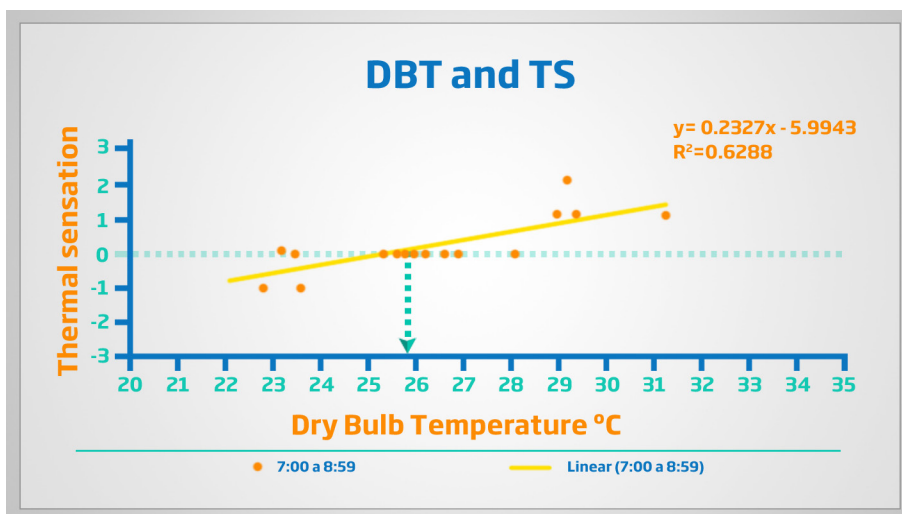

Figure 11. Data analysis by regression of minimal squares. Thermal sensation (TS) and Dry Bulb Temperature (DBT).

In Figure 11 people's thermal sensation is plotted on the y-axis and at "X" axis the Dry Bulb Temperature (DBT).

Once the data are entered a trend line is added asking for a R-value to determine the degree of correlation between the data. The R-value of 0.6288 indicates that there is a relationship between the data and they are not fortuitous. It is important to note that the ideal R is the value 0.9 , but with the limited data obtained in the field the value is high since by increasing it by 100 cases it is likely to be around 0.8 or 0.9 . After obtaining the trend line you can get the neutral temperature (Nt),which can be expressed graphically as seen in Figure 11 or by replacing the "zero" value in the line equation , clearing the value of " X " . The resulting Nt is 25.8 ° C , which for practical purposes is rounded to 26 ° C. Once you get the Nt it is added and 2.5 is subtracted to determine the limits of the comfort zone . Finally, the comfort zone that was obtained was between 23.5 ° C to 28.5 ° C. Nt is 26 ° C.

Nt was compared with two adaptive models obtained in similar climates. The results are as follows: In Brager-De Dear (1998) , the formula is $Nt = 17.38 + (0.31 * Tm)$, Tm being the middle of the month for analysis or in this case, annually. For Humphreys -Nicol (2000) , the formula is $Nt = 13.5 + (0.51 * Tm)$. The substitute value what was chosen was the TBS average for January, obtaining the historic SMN from climatological norms, which in January for Ostuacan the At is 25.7 ° C.

The results in Table 1 indicate that obtained in " Tn " complies with the parameters mentioned under adaptive approach , the difference between the models is minimal, thus could be used to preliminarily evaluate thermal behavior conditions dwellings rural town , staying with Tn = 26 ° C with a comfort zone that ranges from 23.5 ° C to 28.5 ° C.

Brager-De Dear (1998)	Tn=	25.3
Humphreys - Nicol (2000)	Tn=	26.6

Table 1: Calculation of Nt with two adaptive models for the month of January.

Results of the thermal behavior

The result of the housing evaluation in reference to comfort zone obtained from this investigation indicates that there are comfortable conditions practically all day, with the exception of the early morning hours when there were feelings of cold. It is noteworthy that no critical cold conditions were present considering the type of climate that prevails in the region.

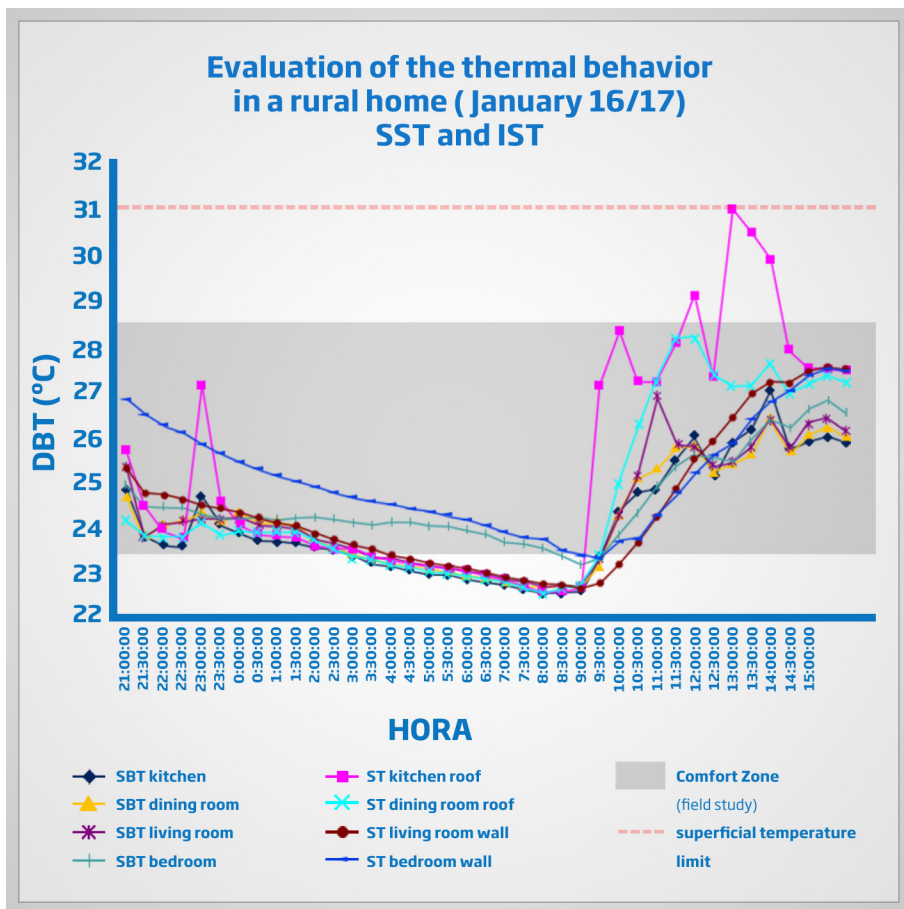

Figure 12: Evaluation of the thermal behavior in a rural home (January 16/17) SST and IST

The inner surface temperature was compared with the skin surface temperature (31 ° C to 34 ° C according to Auliciems and Szokolay, 1999). This parameter is indicated in Figure 12 by a red line , and as can be observed, the surface temperatures of the roofs and walls do not exceed this limit. The system infers that the roof sandwich, which is composed of two layers of fiber cement with two inches of polystyrene, mitigates solar radiation gain in the roof .

Conclusions

The evaluation of the thermal behavior of the rural city housing in Nuevo Juan de Grijalva for the month of January presents comfortable conditions during the day. This was checked by analyzing the comfort of the inhabitants using a comfort zone obtained under the adaptive approach, which is usually above international standards with the premise that people tend to adapt to the weather conditions they experience. However, the comfort zone and neutral temperature coincide with adaptive models used more often in thermal comfort studies. On the other hand, the surface temperature of the roof and walls presented optimal conditions regarding their thermal performance since they did not exceed the limit of the surface skin temperature.

These results will be compared with future studies which will be conducted in the warmer months, but it can be inferred that the results will be similar regarding the surface temperature variable, the opposite can be expected for the interior dry bulb temperature because this is directly influenced by the outside air temperature.

References

Aulliciems and **Szokolay** (1999). *S. V. Thermal comfort*. PLEA Notes, Brisbane (Australia) , PLEA : Passive and Low Energy Architecture. University of Queensland.

National Water Commission and the National Meteorological System .Website : <http://smn.cna.gob.mx>
 .Gómez- Azpeitia , G. , Bojorquez , G. Ruiz , RP , Romero , RA , Ochoa , JM , Perez, M. ,

Resendiz , J. and **Llamas**, A. (2009). *Comfort Temperatures inside low - cost housings of six warm climate cities in Mexico* , PLEA 2009 . The 26th International Conference , 21-24 June 2009 .

Ruiz Torres , R. P. (2011) . *Thermal comfort in variable warm humid climate* .

Coquimatlán , Colima. : *Doctoral Thesis ASK program* .

Ruiz Torres , R. P. , &CastañedaNolasco , G. (2012) . *Preliminary Study of Thermal Comfort housing in sustainable city* . Mexico

Vecchia , Francisco , (1997) . *Thesis : Climate and built environment. A dynamic abordagem applied ao With Human forto* . San Pablo , FFLCH USP .

Academic Document

Educational inequity in Chiapas, a matter of social justice

Hilda Maria Jimenez Acevedo

About the author

Full time professor at the Autonomous University of Chiapas. Paper presented at the Mexican Education Forum on Quality Education, held in Palenque Chiapas on April 10, 2013. This forum brought together experts, researchers and representatives of different social sectors to contribute their proposals for the Education sector of the National Development Plan 2013-2018.

The education gap is one of the elements of the cycle of poverty, together with malnutrition, high morbidity and mortality rates, low productivity and income, lack of natural and financial resources, poor housing conditions, lack and poor quality of food and high fertility rate.

Therefore, poverty and the lack of education are two closely related conditions; the educational gap is a structural phenomenon that affects the economic and social development of countries and their people, particularly in less developed regions.

The education gap and illiteracy limit the full development of citizens and their participation in society, negatively impacting their lives, affecting their family environment, restricting access to the benefits of development and hindering the enjoyment of other human rights.

To understand the educational gap as a social problem, it is recommended to conduct an analysis considering its multi causality. In order to address the educational gap, integrated strategies should be sought otherwise it would be difficult to obtain the results and impact that is required.

The following diagram presents an analysis of the problem.

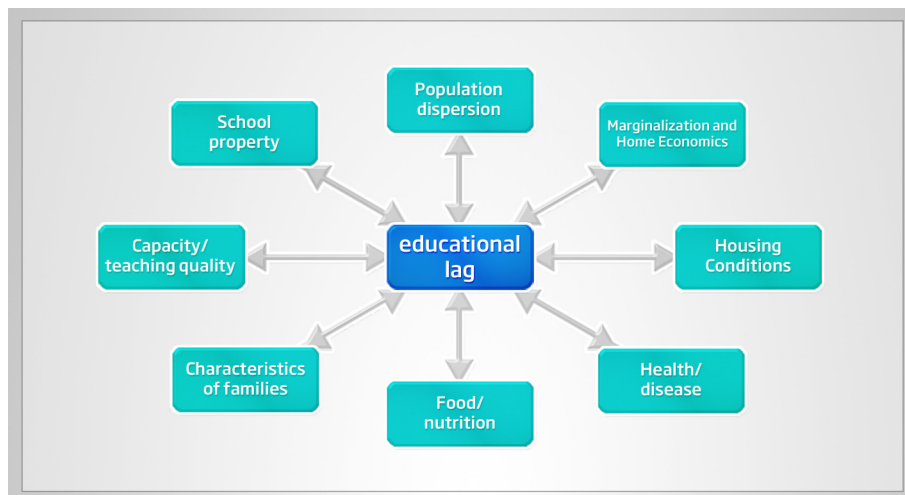

Figure 1. Multi causal analysis of educational lag

As can be seen in Figure 1, among the causes are found: dispersed population; economic marginalization and household economic

level; the dual health / disease and food / nutrition interactions; family characteristics; poor housing conditions; school characteristics, and the capacity and quality of teachers.

The following is a review of the data associated with these causes related to the problem of the educational gap in the State of Chiapas:

Dispersed population. The state has 122 municipalities and 20,475 population centers, with a population density of 65 inhabitants per km²; 51% of the population is rural, with 19,873 towns and settlements with less than 2500 inhabitants (INEGI, 2010). This condition impacts the creation of service infrastructure, the quality of those services, as well as the time and cost of moving people and products.

Marginalization and household economic status. Chiapas, Oaxaca and Guerrero are last in national income level. The Federal District earns 3.7 times the per capita income of Chiapas. In 2010, the economically active population over 14 (EAP) in the formal sector was 57%, with 43% in the service sector, 43% in agriculture and 14% in industry (INEGI, 2010). The data shows that 32% of households and 29% of the population have a monthly income of less than minimum wage. (ENSANUT, 2006).

In rural areas the planting and harvest seasons do not coincide with the school calendar and the need of many families to incorporate children and adolescents in economic activities is well known. On the other hand, there are cases where there is a lack of resources to continue studying. Both favor school abandonment and truancy.

Family characteristics. Chiapas has a functional illiteracy level of 24%, the highest in the country. The population over 15 years old who cannot read and write is 17.8%, among which there are 14 men for every 22 women. Additionally, children of illiterate parents have learning limitations of reading, writing, and communication codes, and nutritional, health and hygiene deficiencies. They also have a high level of socioeconomic vulnerability which is reflected in low productivity and employability. In addition to having illiterate parents who only communicate in their native indigenous language, the difficulties increase when it comes time for these parents to support their children's education. This leads to high dropout rates for children and youth, since school is given little value and importance.

Regarding ethnicity. The state ranks first nationally in monolingualism (INEGI, 2012). The educational gap is reflected significantly among the

indigenous population, which is no coincidence as the data reflects greater levels of poverty in this group. In the cases of monolingual illiteracy for those over 15, it is essential that you first promote literacy in their native language and then later conduct the process in Spanish. This approach is infrequently considered in literacy programs.

Housing conditions. Data on basic services in Chiapas are: 54% of households are connected to sewage systems, 1.5% are connected to a septic tank and 1.5% drain directly to a river, lake or ravine; 52% of households have water available inside their homes, 32% have exterior running water and 17% have water from a non plumbed source; 96% have electricity and 85% have concrete floors. 52% of households are in rural areas and 54% of them have some kind of overcrowding (INEGI, 2010), (ENSANUT, 2006).

Binomial health / disease. The infant mortality rate of Chiapas in children under 5 years is 5 points higher than the national average. In children under 15 years, one in four deaths in 2011 was from diarrhea or respiratory illness (CNEGS, 2012). There is one doctor for every 1600 inhabitants, while the national average is one per 1070. The problem lies in the poor distribution of staff in the state, as it is concentrated in the larger cities and municipalities. Additionally, it is registered that 90% of school children and youth do not realize sufficient physical activity to improve their growth (CODEME, 2012).

Food / nutrition. In 60 municipalities in Chiapas there is severe malnutrition, in 36 municipalities there is a significant degree of malnutrition, in 13 it is moderate and in 2 it is mild (Cortés, 2006). 84% of the population living in alimentary poverty lives in an indigenous home. One third of children living in rural locations are short statured or stunted, and 10% of the children of the State are underweight (ENSANUT, 2006).

Food is essential for the full psychological and social development of an individual. A poor diet that causes malnutrition in children under 5 years is represented as stunted growth, higher incidence of disease (some associated with causes of death), increased mental health disorders and impaired mental performance. Additionally, obesity in children and youth are considered among the consequences of a poor diet, together with the increase in health problems that this entails.

The quality and capacity of teachers. The PISA and ENLACE test results, among other student performance assessments in Mexico, reveal major deficiencies in the educational system. This is not just a

matter of the training, updating and evaluation of teachers, but also implies the need to review, modernize and strengthen the curriculum when being written or are under review. In the case of teachers who will teach indigenous children, special training must be given in order to develop the required skills and competencies.

The characteristics of the schools. In Chiapas there are almost 9000 primary schools, of which 39% are served by a single teacher and 21% by two teachers. This means that 60% of primary schools have between 1-2 teachers, with the implications that this situation has on the quality of education (SE, 2011).

Reflections

Finally, an element of the analysis of educational gap can be added: The efficiency, efficacy, and effectiveness of public policy; that while seeking better use of assets and (often scarce)resources, also privilege groups and sectors which distort its intended purpose. Moreover, there is a lack of monitoring and evaluation of results and impacts of their interventions, which has led to repeating strategies that have been proven to not yield results.

Traditionally there is a lack of coordination between different government sectors and other stakeholders involved in education in Mexico. There are plenty of programs operating in isolation that do not make an impact and result in a waste of resources and time. Just to cite one example that addresses malnutrition in the country, according to Dr. Marcos Arana there are over 50 state, national and international programs among public, private, and civil society- and there is neither progress in the results nor impacts of the programs.

Any analysis done on the different issues and problems of society are found to be interdependent: in everyday life social issues impact economic, cultural, political, and environmental issues, and vice versa. While it is good that the public administration attends to society through sector programs, this does not mean that they are isolated. Therefore one of the major challenges has been and continues to be achieving coordination and collaboration between sectors and programs.

Proposals

It is required to unite efforts and the will to work in aligning programs and actions, starting with the problems. In the case of the educational gap, it is necessary to have a master plan that has a 30-year prospective which involves all public and private stakeholders that form part of the multi causality. There should be an initial solid baseline, continuous monitoring and a permanent evaluation of results and impacts in both the short and medium term in order to make the shifts and adjustments necessary to ensure the abatement of the educational gap. In order that it is not for special interests, patrons or groups, it is necessary that the beneficiaries and their parents are included among the stakeholders.

To address the educational gap in poor, scattered areas, we propose the creation of Educational Centers for Integral Development (CEDI), which should be led by qualified professionals to concentrate children and teachers from different far removed settlements in spaces with complete, quality infrastructure. They should have adequate monitoring of the food and health of the children and youth, and it is necessary to incorporate sports and cultural activities into the curriculum. The culture of the group will need to be considered in the case that they are located in indigenous communities. It is necessary to develop life skills. They must have as a principle the formation of values, discipline and order. It is essential to carry out a continuous self-assessment to prevent the CEDI's from detracting from their goals, ensure the integrity of the children, and ensure the timely allocation of resources necessary for their operation.

The right to education is key to the empowerment of people- the educational gap is a major obstacle to the development of society. If we want to transform Mexico, the tool is education. As Albert Einstein said:

"Insanity is doing the same thing over and over again and expecting different results."

Let's leave behind the madness that has engulfed us and let us dare to do things differently to break the cycle of poverty, which according to Sigmund Freud, is associated with eternal human suffering and discomfort. This condition has elements of violence that sooner or later will affect Mexico's social fabric (Jolibert, 2001, p. 1-11).

References

CDI. (2005). Indicadores Sociodemográficos de la Población Indígena 2000-2005. Obtenido de Comisión Nacional para el Desarrollo de los Pueblos Indígenas: http://www.cdi.gob.mx/index.php?option=com_content&view=article&id=1327:cedulas-de-informacion-basica-de-los-pueblos-indigenas-demexico-&catid=38&Itemid=54.

CNEGS. (2012). Informe de Rendición de Cuentas 2006-2012. Obtenido de Centro Nacional de Equidad de Género y Salud, Gobierno Federal: http://www.generoysaludreproductiva.gob.mx/images/stories/Transparencia/Docs/Rendicion/tmp_irc_cnegsr%20final%2031%20julio%2012.pdf

CNEGSR. (2012). Informe de Rendición de Cuentas 2006-2012. Obtenido de Centro Nacional de Equidad de Género y Salud Reproductiva, Secretaría de Salud, Gobierno Federal: http://www.generoysaludreproductiva.gob.mx/images/stories/Transparencia/Docs/Rendicion/tmp_irc_cnegsr%20final%2031%20julio%2012.pdf

CODEME. (2012). Programa de Desarrollo del Deporte 2012-2018. Confederación Deportiva Mexicana.

CONAPO. (2010). Esperanza de vida por entidad federativa según sexo, 2006-2012. Obtenido de <http://www.inegi.org.mx/sistemas/siseppt/Default.aspx?t=mdemo568&s=est&c=23600>

Cortés, F. (2006). Perfiles de la pobreza en Chiapas (informe final). México, D.F.: Centro de Estudios Sociológicos del Colegio de México.

ENSANUT. (2006). Encuesta Nacional de Salud y Nutrición 2006. Resultados por entidad federativa, Chiapas. Obtenido de Instituto de Salud Pública, Secretaría de Salud, Gobierno Federal: <http://www.insp.mx/ensa-nut/sur/Chiapas.pdf>

INEGI. (2010). Censo de Población y Vivienda 2010. Recuperado el 10 de Octubre de 2012, de Instituto Nacional de Estadística, Geografía e Información: <http://www.censo2010.org.mx/>

INEGI. (2010). México en cifras, información nacional por entidad federativa y municipios. Obtenido de Instituto Nacional de Estadística, Geografía e Información: <http://www3.inegi.org.mx/sistemas/mexicocifras/default.aspx>

INEGI. (2012). *Perspectiva Estadísticas de Chiapas*. Tuxtla, Gtz. Chiapas: Gobierno del Estado de Chiapas.

Jolibert, .. (2001). *La educación de la emoción*. Obtenido de UNESCO: [www.ibe.unesco.org: http://www.ibe.unesco.org/publications/ThinkersPdf/freuds.pdf](http://www.ibe.unesco.org/publications/ThinkersPdf/freuds.pdf)

PNUD. (s.f.). Programa de Naciones Unidas para el Derecho a la Alimentación. Obtenido de Organización de las Naciones Unidas .

